

## CHAPTER 23

# WOOD

### SECTION 2301 GENERAL

**2301.1 Scope.** The provisions of this chapter shall govern the materials, design, construction and quality of wood members and their fasteners.

**2301.2 General design requirements.** The design of structural elements or systems, constructed partially or wholly of wood or wood-based products, shall be in accordance with one of the following methods:

1. *Allowable stress design* in accordance with Sections 2304, 2305 and 2306.
2. *Load and resistance factor design* in accordance with Sections 2304, 2305 and 2307.
3. *Conventional light-frame construction* in accordance with Sections 2304 and 2308.

**Exception:** Buildings designed in accordance with the provisions of the AF&PA WFCM shall be deemed to meet the requirements of the provisions of Section 2308.

4. The design and construction of log structures shall be in accordance with the provisions of ICC 400.

**2301.3 Nominal sizes.** For the purposes of this chapter, where dimensions of lumber are specified, they shall be deemed to be nominal dimensions unless specifically designated as actual dimensions (see Section 2304.2).

### SECTION 2302 DEFINITIONS

**2302.1 Definitions.** The following terms are defined in Chapter 2:

**ACCREDITATION BODY.**

**BRACED WALL LINE.**

**BRACED WALL PANEL.**

**COLLECTOR.**

**CONVENTIONAL LIGHT-FRAME CONSTRUCTION.**

**CRIPPLE WALL.**

**DIAPHRAGM, UNBLOCKED.**

**DRAG STRUT.**

**FIBERBOARD.**

**GLUED BUILT-UP MEMBER.**

**GRADE (LUMBER).**

**HARDBOARD.**

**NAILING, BOUNDARY.**

**NAILING, EDGE.**

**NAILING, FIELD.**

**NOMINAL SIZE (LUMBER).**

**PARTICLEBOARD.**

**PERFORMANCE CATEGORY.**

**PREFABRICATED WOOD I-JOIST.**

**SHEAR WALL.**

**Shear wall, perforated.**

**Shear wall segment, perforated.**

**STRUCTURAL COMPOSITE LUMBER.**

**Laminated strand lumber (LSL).**

**Laminated veneer lumber (LVL).**

**Oriented strand lumber (OSL).**

**Parallel strand lumber (PSL).**

**STRUCTURAL GLUED-LAMINATED TIMBER.**

**SUBDIAPHRAGM.**

**TIE-DOWN (HOLD-DOWN).**

**TREATED WOOD.**

**Fire-retardant-treated wood.**

**Preservative-treated wood.**

**WOOD SHEAR PANEL.**

**WOOD STRUCTURAL PANEL.**

**Composite panels.**

**Oriented strand board (OSB).**

**Plywood.**

### SECTION 2303 MINIMUM STANDARDS AND QUALITY

**2303.1 General.** Structural sawn lumber; end-jointed lumber; prefabricated wood I-joists; structural glued-laminated timber; wood structural panels, fiberboard sheathing (when used structurally); hardboard siding (when used structurally); particleboard; *preservative-treated wood*; structural log members; structural composite lumber; round timber poles and piles; *fire-retardant-treated wood*; hardwood plywood; wood trusses; joist hangers; nails; and staples shall conform to the applicable provisions of this section.

**2303.1.1 Sawn lumber.** Sawn lumber used for load-supporting purposes, including end-jointed or edge-glued lumber, machine stress-rated or machine-evaluated lumber, shall be identified by the grade *mark* of a lumber grading or inspection agency that has been approved by an accreditation body that complies with DOC PS 20 or equivalent. Grading practices and identification shall comply with rules published by an agency approved in accordance with the procedures of DOC PS 20 or equivalent procedures.

**2303.1.1.1 Certificate of inspection.** In lieu of a grade *mark* on the material, a certificate of inspection as to species and grade issued by a lumber grading or inspection agency meeting the requirements of this section is permitted to be accepted for precut, remanufactured or rough-sawn lumber and for sizes larger than 3 inches (76 mm) nominal thickness.

**2303.1.1.2 End-jointed lumber.** *Approved* end-jointed lumber is permitted to be used interchangeably with solid-sawn members of the same species and grade. End-jointed lumber used in an assembly required to have a fire-resistance rating shall have the designation “Heat Resistant Adhesive” or “HRA” included in its grade mark.

**2303.1.2 Prefabricated wood I-joists.** Structural capacities and design provisions for prefabricated wood I-joists shall be established and monitored in accordance with ASTM D 5055.

**2303.1.3 Structural glued-laminated timber.** Glued-laminated timbers shall be manufactured and identified as required in ANSI/AITC A 190.1 and ASTM D 3737.

**2303.1.4 Wood structural panels.** Wood structural panels, when used structurally (including those used for siding, roof and wall sheathing, subflooring, diaphragms and built-up members), shall conform to the requirements for their type in DOC PS 1, DOC PS 2 or ANSI/APA PRP 210. Each panel or member shall be identified for grade, bond classification, and Performance Category by the trademarks of an *approved* testing and grading agency. The Performance Category value shall be used as the “nominal panel thickness” or “panel thickness” whenever referenced in this code. Wood structural panel components shall be designed and fabricated in accordance with the applicable standards listed in Section 2306.1 and identified by the trademarks of an *approved* testing and inspection agency indicating conformance to the applicable standard. In addition, wood structural panels when permanently exposed in outdoor applications shall be of Exterior type, except that wood structural panel roof sheathing exposed to the outdoors on the underside is permitted to be Exposure 1 type.

**2303.1.5 Fiberboard.** Fiberboard for its various uses shall conform to ASTM C 208. Fiberboard sheathing, when used structurally, shall be identified by an *approved* agency as conforming to ASTM C 208.

**2303.1.5.1 Jointing.** To ensure tight-fitting assemblies, edges shall be manufactured with square, shiplapped, beveled, tongue-and-groove or U-shaped joints.

**2303.1.5.2 Roof insulation.** Where used as roof insulation in all types of construction, fiberboard shall be protected with an *approved* roof covering.

**2303.1.5.3 Wall insulation.** Where installed and fire-blocked to comply with Chapter 7, fiberboards are permitted as wall insulation in all types of construction. In fire walls and fire barriers, unless treated to comply with Section 803.1 for Class A materials, the boards shall be cemented directly to the concrete, masonry or

other noncombustible base and shall be protected with an *approved* noncombustible veneer anchored to the base without intervening airspaces.

**2303.1.5.3.1 Protection.** Fiberboard wall insulation applied on the exterior of foundation walls shall be protected below ground level with a bituminous coating.

**2303.1.6 Hardboard.** Hardboard siding used structurally shall be identified by an *approved* agency conforming to CPA/ANSI A135.6. Hardboard underlayment shall meet the strength requirements of  $\frac{7}{32}$ -inch (5.6 mm) or  $\frac{1}{4}$ -inch (6.4 mm) service class hardboard planed or sanded on one side to a uniform thickness of not less than 0.200 inch (5.1 mm). Prefinished hardboard paneling shall meet the requirements of CPA/ANSI A135.5. Other basic hardboard products shall meet the requirements of CPA/ANSI A135.4. Hardboard products shall be installed in accordance with manufacturer's recommendations.

**2303.1.7 Particleboard.** Particleboard shall conform to ANSI A208.1. Particleboard shall be identified by the grade *mark* or certificate of inspection issued by an *approved* agency. Particleboard shall not be utilized for applications other than indicated in this section unless the particleboard complies with the provisions of Section 2306.3.

**2303.1.7.1 Floor underlayment.** Particleboard floor underlayment shall conform to Type PBU of ANSI A208.1. Type PBU underlayment shall not be less than  $\frac{1}{4}$ -inch (6.4 mm) thick and shall be installed in accordance with the instructions of the Composite Panel Association.

**2303.1.8 Preservative-treated wood.** Lumber, timber, plywood, piles and poles supporting permanent structures required by Section 2304.11 to be preservative treated shall conform to the requirements of the applicable AWWA Standard U1 and M4 for the species, product, preservative and end use. Preservatives shall be listed in Section 4 of AWWA U1. Lumber and plywood used in wood foundation systems shall conform to Chapter 18.

**2303.1.8.1 Identification.** Wood required by Section 2304.11 to be preservative treated shall bear the quality *mark* of an inspection agency that maintains continuing supervision, testing and inspection over the quality of the *preservative-treated wood*. Inspection agencies for *preservative-treated wood* shall be *listed* by an accreditation body that complies with the requirements of the American Lumber Standards Treated Wood Program, or equivalent. The quality *mark* shall be on a stamp or label affixed to the *preservative-treated wood*, and shall include the following information:

1. Identification of treating manufacturer.
2. Type of preservative used.
3. Minimum preservative retention (pcf).
4. End use for which the product is treated.
5. AWWA standard to which the product was treated.
6. Identity of the accredited inspection agency.

**2303.1.8.2 Moisture content.** Where *preservative-treated wood* is used in enclosed locations where drying in service cannot readily occur, such wood shall be at a moisture content of 19 percent or less before being covered with insulation, interior wall finish, floor covering or other materials.

**2303.1.9 Structural composite lumber.** Structural capacities for structural composite lumber shall be established and monitored in accordance with ASTM D 5456.

**2303.1.10 Structural log members.** Stress grading of structural log members of nonrectangular shape, as typically used in log buildings, shall be in accordance with ASTM D 3957. Such structural log members shall be identified by the *grade mark* of an *approved* lumber grading or inspection agency. In lieu of a *grade mark* on the material, a certificate of inspection as to species and *grade* issued by a lumber grading or inspection agency meeting the requirements of this section shall be permitted.

**2303.1.11 Round timber poles and piles.** Round timber poles and piles shall comply with ASTM D 3200 and ASTM D 25, respectively.

**2303.2 Fire-retardant-treated wood.** *Fire-retardant-treated wood* is any wood product which, when impregnated with chemicals by a pressure process or other means during manufacture, shall have, when tested in accordance with ASTM E 84 or UL 723, a *listed* flame spread index of 25 or less and show no evidence of significant progressive combustion when the test is continued for an additional 20-minute period. Additionally, the flame front shall not progress more than 10<sup>1</sup>/<sub>2</sub> feet (3200 mm) beyond the centerline of the burners at any time during the test.

**2303.2.1 Pressure process.** For wood products impregnated with chemicals by a pressure process, the process shall be performed in closed vessels under pressures not less than 50 pounds per square inch gauge (psig) (345 kPa).

**2303.2.2 Other means during manufacture.** For wood products produced by other means during manufacture, the treatment shall be an integral part of the manufacturing process of the wood product. The treatment shall provide permanent protection to all surfaces of the wood product.

**2303.2.3 Testing.** For wood products produced by other means during manufacture, other than a pressure process, all sides of the wood product shall be tested in accordance with and produce the results required in Section 2303.2. Wood structural panels shall be permitted to test only the front and back faces.

**2303.2.4 Labeling.** Fire-retardant-treated lumber and wood structural panels shall be labeled. The *label* shall contain the following items:

1. The identification *mark* of an *approved agency* in accordance with Section 1703.5.
2. Identification of the treating manufacturer.
3. The name of the fire-retardant treatment.
4. The species of wood treated.

5. Flame spread and smoke-developed index.

6. Method of drying after treatment.

7. Conformance with appropriate standards in accordance with Sections 2303.2.5 through 2303.2.8.

8. For *fire-retardant-treated wood* exposed to weather, damp or wet locations, include the words “No increase in the *listed* classification when subjected to the Standard Rain Test” (ASTM D 2898).

**2303.2.5 Strength adjustments.** Design values for untreated lumber and wood structural panels, as specified in Section 2303.1, shall be adjusted for *fire-retardant-treated wood*. Adjustments to design values shall be based on an *approved* method of investigation that takes into consideration the effects of the anticipated temperature and humidity to which the *fire-retardant-treated wood* will be subjected, the type of treatment and redrying procedures.

**2303.2.5.1 Wood structural panels.** The effect of treatment and the method of redrying after treatment, and exposure to high temperatures and high humidities on the flexure properties of fire-retardant-treated softwood plywood shall be determined in accordance with ASTM D 5516. The test data developed by ASTM D 5516 shall be used to develop adjustment factors, maximum loads and spans, or both, for untreated plywood design values in accordance with ASTM D 6305. Each manufacturer shall publish the allowable maximum loads and spans for service as floor and roof sheathing for its treatment.

**2303.2.5.2 Lumber.** For each species of wood that is treated, the effects of the treatment, the method of redrying after treatment and exposure to high temperatures and high humidities on the allowable design properties of fire-retardant-treated lumber shall be determined in accordance with ASTM D 5664. The test data developed by ASTM D 5664 shall be used to develop modification factors for use at or near room temperature and at elevated temperatures and humidity in accordance with ASTM D 6841. Each manufacturer shall publish the modification factors for service at temperatures of not less than 80°F (27°C) and for roof framing. The roof framing modification factors shall take into consideration the climatological location.

**2303.2.6 Exposure to weather, damp or wet locations.** Where *fire-retardant-treated wood* is exposed to weather, or damp or wet locations, it shall be identified as “Exterior” to indicate there is no increase in the *listed* flame spread index as defined in Section 2303.2 when subjected to ASTM D 2898.

**2303.2.7 Interior applications.** Interior *fire-retardant-treated wood* shall have moisture content of not over 28 percent when tested in accordance with ASTM D 3201 procedures at 92-percent relative humidity. Interior *fire-retardant-treated wood* shall be tested in accordance with Section 2303.2.5.1 or 2303.2.5.2. Interior *fire-retardant-treated wood* designated as Type A shall be tested in accordance with the provisions of this section.

**2303.2.8 Moisture content.** *Fire-retardant-treated wood* shall be dried to a moisture content of 19 percent or less for lumber and 15 percent or less for wood structural panels before use. For wood kiln dried after treatment (KDAT), the kiln temperatures shall not exceed those used in kiln drying the lumber and plywood submitted for the tests described in Section 2303.2.5.1 for plywood and 2303.2.5.2 for lumber.

**2303.2.9 Type I and II construction applications.** See Section 603.1 for limitations on the use of *fire-retardant-treated wood* in buildings of Type I or II construction.

**2303.3 Hardwood and plywood.** Hardwood and decorative plywood shall be manufactured and identified as required in HPVA HP-1.

**2303.4 Trusses.** Wood trusses shall comply with Sections 2303.4.1 through 2303.4.7.

**2303.4.1 Design.** Wood trusses shall be designed in accordance with the provisions of this code and accepted engineering practice. Members are permitted to be joined by nails, glue, bolts, timber connectors, metal connector plates or other *approved* framing devices.

**2303.4.1.1 Truss design drawings.** The written, graphic and pictorial depiction of each individual truss shall be provided to the *building official* for approval prior to installation. Truss design drawings shall also be provided with the shipment of trusses delivered to the job site. Truss design drawings shall include, at a minimum, the information specified below:

1. Slope or depth, span and spacing;
2. Location of all joints and support locations;
3. Number of plies if greater than one;
4. Required bearing widths;
5. Design loads as applicable, including:
  - 5.1. Top chord live load;
  - 5.2. Top chord dead load;
  - 5.3. Bottom chord live load;
  - 5.4. Bottom chord dead load;
  - 5.5. Additional loads and locations; and
  - 5.6. Environmental design criteria and loads (wind, rain, snow, seismic, etc.).
6. Other lateral loads, including drag strut loads;
7. Adjustments to wood member and metal connector plate design value for conditions of use;
8. Maximum reaction force and direction, including maximum uplift reaction forces where applicable;
9. Metal-connector-plate type, size and thickness or gage, and the dimensioned location of each metal connector plate except where symmetrically located relative to the joint interface;
10. Size, species and grade for each wood member;

11. Truss-to-truss connections and truss field assembly requirements;
12. Calculated span-to-deflection ratio and maximum vertical and horizontal deflection for live and total load as applicable;
13. Maximum axial tension and compression forces in the truss members; and
14. Required permanent individual truss member restraint location and the method and details of restraint/bracing to be used in accordance with Section 2303.4.1.2.

**2303.4.1.2 Permanent individual truss member restraint.** Where permanent restraint of truss members is required on the truss design drawings, it shall be accomplished by one of the following methods:

1. Permanent individual truss member restraint/bracing shall be installed using standard industry lateral restraint/bracing details in accordance with generally accepted engineering practice. Locations for lateral restraint shall be identified on the truss design drawing.
2. The trusses shall be designed so that the buckling of any individual truss member is resisted internally by the individual truss through suitable means (i.e., buckling reinforcement by T-reinforcement or L-reinforcement, proprietary reinforcement, etc.). The buckling reinforcement of individual members of the trusses shall be installed as shown on the truss design drawing or on supplemental truss member buckling reinforcement details provided by the truss designer.
3. A project-specific permanent individual truss member restraint/bracing design shall be permitted to be specified by any *registered design professional*.

**2303.4.1.3 Trusses spanning 60 feet or greater.** The owner shall contract with any qualified *registered design professional* for the design of the temporary installation restraint/bracing and the permanent individual truss member restraint/bracing for all trusses with clear spans 60 feet (18 288 mm) or greater.

**2303.4.1.4 Truss designer.** The individual or organization responsible for the design of trusses.

**2303.4.1.4.1 Truss design drawings.** Where required by the *registered design professional*, the *building official* or the statutes of the jurisdiction in which the project is to be constructed, each individual truss design drawing shall bear the seal and signature of the truss designer.

**Exceptions:**

1. Where a cover sheet and truss index sheet are combined into a single sheet and attached to the set of truss design drawings, the single cover/truss index sheet is the only document required to be signed and sealed by the truss designer.

2. When a cover sheet and a truss index sheet are separately provided and attached to the set of truss design drawings, the cover sheet and the truss index sheet are the only documents required to be signed and sealed by the truss designer.

**2303.4.2 Truss placement diagram.** The truss manufacturer shall provide a truss placement diagram that identifies the proposed location for each individually designated truss and references the corresponding truss design drawing. The truss placement diagram shall be provided as part of the truss submittal package, and with the shipment of trusses delivered to the job site. Truss placement diagrams that serve only as a guide for installation and do not deviate from the *permit* submittal drawings shall not be required to bear the seal or signature of the truss designer.

**2303.4.3 Truss submittal package.** The truss submittal package provided by the truss manufacturer shall consist of each individual truss design drawing, the truss placement diagram, the permanent individual truss member restraint/bracing method and details and any other structural details germane to the trusses; and, as applicable, the cover/truss index sheet.

**2303.4.4 Anchorage.** The design for the transfer of loads and anchorage of each truss to the supporting structure is the responsibility of the *registered design professional*.

**2303.4.5 Alterations to trusses.** Truss members and components shall not be cut, notched, drilled, spliced or otherwise altered in any way without written concurrence and approval of a *registered design professional*. Alterations resulting in the addition of loads to any member (e.g., HVAC equipment, piping, additional roofing or insulation, etc.) shall not be permitted without verification that the truss is capable of supporting such additional loading.

**2303.4.6 TPI 1 specifications.** In addition to Sections 2303.4.1 through 2303.4.5, the design, manufacture and quality assurance of metal-plate-connected wood trusses shall be in accordance with TPI 1. Job-site inspections shall be in compliance with Section 110.4, as applicable.

**2303.4.7 Truss quality assurance.** Trusses not part of a manufacturing process in accordance with either Section 2303.4.6 or a referenced standard, which provides requirements for quality control done under the supervision of a third-party quality control agency, shall be manufactured in compliance with Sections 1704.2.5 and 1705.5, as applicable.

**2303.5 Test standard for joist hangers.** For the required test standards for joist hangers see Section 1711.1.

**2303.6 Nails and staples.** Nails and staples shall conform to requirements of ASTM F 1667. Nails used for framing and sheathing connections shall have minimum average bending yield strengths as follows: 80 kips per square inch (ksi) (551 MPa) for shank diameters larger than 0.177 inch (4.50 mm) but not larger than 0.254 inch (6.45 mm), 90 ksi (620 MPa) for shank diameters larger than 0.142 inch (3.61 mm) but not larger than 0.177 inch (4.50 mm) and 100 ksi (689 MPa) for

shank diameters of at least 0.099 inch (2.51 mm) but not larger than 0.142 inch (3.61 mm).

**2303.7 Shrinkage.** Consideration shall be given in design to the possible effect of cross-grain dimensional changes considered vertically which may occur in lumber fabricated in a green condition.

## SECTION 2304

### GENERAL CONSTRUCTION REQUIREMENTS

**2304.1 General.** The provisions of this section apply to design methods specified in Section 2301.2.

**2304.2 Size of structural members.** Computations to determine the required sizes of members shall be based on the net dimensions (actual sizes) and not nominal sizes.

**2304.3 Wall framing.** The framing of exterior and interior walls shall be in accordance with the provisions specified in Section 2308 unless a specific design is furnished.

**2304.3.1 Bottom plates.** Studs shall have full bearing on a 2-inch-thick (actual 1½-inch, 38 mm) or larger plate or sill having a width at least equal to the width of the studs.

**2304.3.2 Framing over openings.** Headers, double joists, trusses or other *approved* assemblies that are of adequate size to transfer loads to the vertical members shall be provided over window and door openings in load-bearing walls and partitions.

**2304.3.3 Shrinkage.** Wood walls and bearing partitions shall not support more than two floors and a roof unless an analysis satisfactory to the *building official* shows that shrinkage of the wood framing will not have adverse effects on the structure or any plumbing, electrical or mechanical systems, or other equipment installed therein due to excessive shrinkage or differential movements caused by shrinkage. The analysis shall also show that the roof drainage system and the foregoing systems or equipment will not be adversely affected or, as an alternate, such systems shall be designed to accommodate the differential shrinkage or movements.

**2304.4 Floor and roof framing.** The framing of wood-joisted floors and wood framed roofs shall be in accordance with the provisions specified in Section 2308 unless a specific design is furnished.

**2304.5 Framing around flues and chimneys.** Combustible framing shall be a minimum of 2 inches (51 mm), but shall not be less than the distance specified in Sections 2111 and 2113 and the *Mechanical Code*, from flues, chimneys and fireplaces, and 6 inches (152 mm) away from flue openings.

**2304.6 Wall sheathing.** Except as provided for in Section 1405 for weatherboarding or where stucco construction that complies with Section 2510 is installed, enclosed buildings shall be sheathed with one of the materials of the nominal thickness specified in Table 2304.6 or any other *approved* material of equivalent strength or durability.

**2304.6.1 Wood structural panel sheathing.** Where wood structural panel sheathing is used as the exposed finish on the outside of exterior walls, it shall have an exterior expo-

**WOOD**

sure durability classification. Where wood structural panel sheathing is used elsewhere, but not as the exposed finish, it shall be of a type manufactured with exterior glue (Exposure 1 or Exterior). Wood structural panel wall sheathing or siding used as structural sheathing shall be capable of resisting wind pressures in accordance with Section 1609. Maximum wind speeds for wood structural panel sheathing used to resist wind pressures shall be in accordance with Table 2304.6.1 for enclosed buildings with a mean roof height not greater than 30 feet (9144 mm) and a topographic factor ( $K_{zt}$ ) of 1.0.

**2304.6.2 Interior paneling.** Softwood wood structural panels used for interior paneling shall conform to the provisions of Chapter 8 and shall be installed in accordance with Table 2304.9.1. Panels shall comply with DOC PS 1, DOC PS 2 or ANSI/APA PRP 210. Prefinished hardboard paneling shall meet the requirements of CPA/ANSI A135.5. Hardwood plywood shall conform to HPVA HP-1.

**2304.7 Floor and roof sheathing.** Structural floor sheathing and structural roof sheathing shall comply with Sections 2304.7.1 and 2304.7.2, respectively.

**2304.7.1 Structural floor sheathing.** Structural floor sheathing shall be designed in accordance with the general provisions of this code and the special provisions in this section.

Floor sheathing conforming to the provisions of Table 2304.7(1), 2304.7(2), 2304.7(3) or 2304.7(4) shall be deemed to meet the requirements of this section.

**2304.7.2 Structural roof sheathing.** Structural roof sheathing shall be designed in accordance with the general provisions of this code and the special provisions in this section.

Roof sheathing conforming to the provisions of Table 2304.7(1), 2304.7(2), 2304.7(3) or 2304.7(5) shall be deemed to meet the requirements of this section. Wood structural panel roof sheathing shall be bonded by exterior glue.

**TABLE 2304.6  
MINIMUM THICKNESS OF WALL SHEATHING**

SHEATHING TYPE	MINIMUM THICKNESS	MAXIMUM WALL STUD SPACING
Wood boards	$\frac{5}{8}$ inch	24 inches on center
Fiberboard	$\frac{1}{2}$ inch	16 inches on center
Wood structural panel	In accordance with Tables 2308.9.3(2) and 2308.9.3(3)	—
M-S “Exterior Glue” and M-2 “Exterior Glue” Particleboard	In accordance with Section 2306.3 and Table 2308.9.3(4)	—
Gypsum sheathing	$\frac{1}{2}$ inch	16 inches on center
Gypsum wallboard	$\frac{1}{2}$ inch	24 inches on center
Reinforced cement mortar	1 inch	24 inches on center

For SI: 1 inch = 25.4 mm.

**TABLE 2304.6.1  
MAXIMUM NOMINAL DESIGN WIND SPEED,  $V_{asd}$  PERMITTED FOR  
WOOD STRUCTURAL PANEL WALL SHEATHING USED TO RESIST WIND PRESSURES<sup>a, b, c</sup>**

MINIMUM NAIL		MINIMUM WOOD STRUCTURAL PANEL SPAN RATING	MINIMUM NOMINAL PANEL THICKNESS (inches)	MAXIMUM WALL STUD SPACING (inches)	PANEL NAIL SPACING		MAXIMUM NOMINAL DESIGN WIND SPEED, $V_{asd}$ <sup>d</sup> (MPH)		
Size	Penetration (inches)				Edges (inches o.c.)	Field (inches o.c.)	Wind exposure category		
							B	C	D
6d common (2.0" × 0.113")	1.5	24/0	$\frac{3}{8}$	16	6	12	110	90	85
		24/16	$\frac{7}{16}$	16	6	12	110	100	90
6	150					125	110		
8d common (2.5" × 0.131")	1.75	24/16	$\frac{7}{16}$	16	6	12	130	110	105
				24		6	150	125	110
					6	12	110	90	85
					6	110	90	85	

For SI: 1 inch = 25.4 mm, 1 mile per hour = 0.447 m/s.

- a. Panel strength axis shall be parallel or perpendicular to supports. Three-ply plywood sheathing with studs spaced more than 16 inches on center shall be applied with panel strength axis perpendicular to supports.
- b. The table is based on wind pressures acting toward and away from building surfaces in accordance with Section 30.7 of ASCE 7. Lateral requirements shall be in accordance with Section 2305 or 2308.
- c. Wood structural panels with span ratings of wall-16 or wall-24 shall be permitted as an alternative to panels with a 24/0 span rating. Plywood siding rated 16 o.c. or 24 o.c. shall be permitted as an alternative to panels with a 24/16 span rating. Wall-16 and plywood siding 16 o.c. shall be used with studs spaced a maximum of 16 inches o.c.
- d.  $V_{asd}$  shall be determined in accordance with Section 1609.3.1.

**2304.8 Lumber decking.** Lumber decking shall be designed and installed in accordance with the general provisions of this code and Sections 2304.8.1 through 2304.8.5.3.

**2304.8.1 General.** Each piece of lumber decking shall be square-end trimmed. When random lengths are furnished, each piece shall be square end trimmed across the face so that at least 90 percent of the pieces are within 0.5 degrees (0.00873 rad) of square. The ends of the pieces shall be permitted to be beveled up to 2 degrees (0.0349 rad) from the vertical with the exposed face of the piece slightly longer than the opposite face of the piece. Tongue-and-groove decking shall be installed with the tongues up on sloped or pitched roofs with pattern faces down.

**2304.8.2 Layup patterns.** Lumber decking is permitted to be laid up following one of five standard patterns as defined in Sections 2304.8.2.1 through 2304.8.2.5. Other patterns are permitted to be used provided they are substantiated through engineering analysis.

**2304.8.2.1 Simple span pattern.** All pieces shall be supported on their ends (i.e., by two supports).

**2304.8.2.2 Two-span continuous pattern.** All pieces shall be supported by three supports, and all end joints shall occur in line on alternating supports. Supporting members shall be designed to accommodate the load redistribution caused by this pattern.

**2304.8.2.3 Combination simple and two-span continuous pattern.** Courses in end spans shall be alternating simple-span pattern and two-span continuous pattern. End joints shall be staggered in adjacent courses and shall bear on supports.

**2304.8.2.4 Cantilevered pieces intermixed pattern.** The decking shall extend across a minimum of three spans. Pieces in each starter course and every third

course shall be simple span pattern. Pieces in other courses shall be cantilevered over the supports with end joints at alternating quarter or third points of the spans. Each piece shall bear on at least one support.

**2304.8.2.5 Controlled random pattern.** The decking shall extend across a minimum of three spans. End joints of pieces within 6 inches (152 mm) of the end joints of the adjacent pieces in either direction shall be separated by at least two intervening courses. In the end bays, each piece shall bear on at least one support. Where an end joint occurs in an end bay, the next piece in the same course shall continue over the first inner support for at least 24 inches (610 mm). The details of the controlled random pattern shall be as specified for each decking material in Section 2304.8.3.3, 2304.8.4.3 or 2304.8.5.3.

Decking that cantilevers beyond a support for a horizontal distance greater than 18 inches (457 mm), 24 inches (610 mm) or 36 inches (914 mm) for 2-inch (51 mm), 3-inch (76 mm) and 4-inch (102 mm) nominal thickness decking, respectively, shall comply with the following:

1. The maximum cantilevered length shall be 30 percent of the length of the first adjacent interior span.
2. A structural fascia shall be fastened to each decking piece to maintain a continuous, straight line.
3. There shall be no end joints in the decking between the cantilevered end of the decking and the centerline of the first adjacent interior span.

**2304.8.3 Mechanically laminated decking.** Mechanically laminated decking shall comply with Sections 2304.8.3.1 through 2304.8.3.3.

**TABLE 2304.7(1)**  
**ALLOWABLE SPANS FOR LUMBER FLOOR AND ROOF SHEATHING<sup>a, b</sup>**

SPAN (inches)	MINIMUM NET THICKNESS (inches) OF LUMBER PLACED			
	Perpendicular to supports		Diagonally to supports	
	Surfaced dry <sup>c</sup>	Surfaced unseasoned	Surfaced dry <sup>c</sup>	Surfaced unseasoned
<b>Floors</b>				
24	$\frac{3}{4}$	$\frac{25}{32}$	$\frac{3}{4}$	$\frac{25}{32}$
16	$\frac{5}{8}$	$\frac{11}{16}$	$\frac{5}{8}$	$\frac{11}{16}$
<b>Roofs</b>				
24	$\frac{5}{8}$	$\frac{11}{16}$	$\frac{3}{4}$	$\frac{25}{32}$

For SI: 1 inch = 25.4 mm.

a. Installation details shall conform to Sections 2304.7.1 and 2304.7.2 for floor and roof sheathing, respectively.

b. Floor or roof sheathing conforming with this table shall be deemed to meet the design criteria of Section 2304.7.

c. Maximum 19-percent moisture content.

**TABLE 2304.7(2)**  
**SHEATHING LUMBER, MINIMUM GRADE REQUIREMENTS: BOARD GRADE**

SOLID FLOOR OR ROOF SHEATHING	SPACED ROOF SHEATHING	GRADING RULES
Utility	Standard	NLGA, WCLIB, WWPA
4 common or utility	3 common or standard	NLGA, WCLIB, WWPA, NSLB or NELMA
No. 3	No. 2	SPIB
Merchantable	Construction common	RIS

**TABLE 2304.7(3)**  
**ALLOWABLE SPANS AND LOADS FOR WOOD STRUCTURAL PANEL SHEATHING AND**  
**SINGLE-FLOOR GRADES CONTINUOUS OVER TWO OR MORE SPANS WITH STRENGTH AXIS PERPENDICULAR TO SUPPORTS<sup>a, b</sup>**

SHEATHING GRADES		ROOF <sup>c</sup>				FLOOR <sup>d</sup>
Panel span rating roof/ floor span	Panel thickness (inches)	Maximum span (inches)		Load <sup>e</sup> (psf)		Maximum span (inches)
		With edge support <sup>f</sup>	Without edge support	Total load	Live load	
16/0	$\frac{3}{8}$	16	16	40	30	0
20/0	$\frac{3}{8}$	20	20	40	30	0
24/0	$\frac{3}{8}, \frac{7}{16}, \frac{1}{2}$	24	20 <sup>g</sup>	40	30	0
24/16	$\frac{7}{16}, \frac{1}{2}$	24	24	50	40	16
32/16	$\frac{15}{32}, \frac{1}{2}, \frac{5}{8}$	32	28	40	30	16 <sup>h</sup>
40/20	$\frac{19}{32}, \frac{5}{8}, \frac{3}{4}, \frac{7}{8}$	40	32	40	30	20 <sup>h,i</sup>
48/24	$\frac{23}{32}, \frac{3}{4}, \frac{7}{8}$	48	36	45	35	24
54/32	$\frac{7}{8}, 1$	54	40	45	35	32
60/32	$\frac{7}{8}, 1\frac{1}{8}$	60	48	45	35	32
SINGLE FLOOR GRADES		ROOF <sup>c</sup>				FLOOR <sup>d</sup>
Panel span rating	Panel thickness (inches)	Maximum span (inches)		Load <sup>e</sup> (psf)		Maximum span (inches)
		With edge support <sup>f</sup>	Without edge support	Total load	Live load	
16 o.c.	$\frac{1}{2}, \frac{19}{32}, \frac{5}{8}$	24	24	50	40	16 <sup>h</sup>
20 o.c.	$\frac{19}{32}, \frac{5}{8}, \frac{3}{4}$	32	32	40	30	20 <sup>h,i</sup>
24 o.c.	$\frac{23}{32}, \frac{3}{4}$	48	36	35	25	24
32 o.c.	$\frac{7}{8}, 1$	48	40	50	40	32
48 o.c.	$1\frac{3}{32}, 1\frac{1}{8}$	60	48	50	40	48

For SI: 1 inch = 25.4 mm, 1 pound per square foot = 0.0479 kN/m<sup>2</sup>.

- Applies to panels 24 inches or wider.
- Floor and roof sheathing conforming with this table shall be deemed to meet the design criteria of Section 2304.7.
- Uniform load deflection limitations  $\frac{1}{180}$  of span under live load plus dead load,  $\frac{1}{240}$  under live load only.
- Panel edges shall have approved tongue-and-groove joints or shall be supported with blocking unless  $\frac{1}{4}$ -inch minimum thickness underlayment or  $1\frac{1}{2}$  inches of approved cellular or lightweight concrete is placed over the subfloor, or finish floor is  $\frac{3}{4}$ -inch wood strip. Allowable uniform load based on deflection of  $\frac{1}{360}$  of span is 100 pounds per square foot except the span rating of 48 inches on center is based on a total load of 65 pounds per square foot.
- Allowable load at maximum span.
- Tongue-and-groove edges, panel edge clips (one midway between each support, except two equally spaced between supports 48 inches on center), lumber blocking or other. Only lumber blocking shall satisfy blocked diaphragm requirements.
- For  $\frac{1}{2}$ -inch panel, maximum span shall be 24 inches.
- Span is permitted to be 24 inches on center where  $\frac{3}{4}$ -inch wood strip flooring is installed at right angles to joist.
- Span is permitted to be 24 inches on center for floors where  $1\frac{1}{2}$  inches of cellular or lightweight concrete is applied over the panels.

**TABLE 2304.7(4)**  
**ALLOWABLE SPAN FOR WOOD STRUCTURAL PANEL COMBINATION SUBFLOOR-UNDERLAYMENT (SINGLE FLOOR)<sup>a, b</sup>**  
**(Panels Continuous Over Two or More Spans and Strength Axis Perpendicular to Supports)**

IDENTIFICATION	MAXIMUM SPACING OF JOISTS (inches)				
	16	20	24	32	48
Species group <sup>c</sup>	Thickness (inches)				
1	$\frac{1}{2}$	$\frac{5}{8}$	$\frac{3}{4}$	—	—
2, 3	$\frac{5}{8}$	$\frac{3}{4}$	$\frac{7}{8}$	—	—
4	$\frac{3}{4}$	$\frac{7}{8}$	1	—	—
Single floor span rating <sup>d</sup>	16 o.c.	20 o.c.	24 o.c.	32 o.c.	48 o.c.

For SI: 1 inch = 25.4 mm, 1 pound per square foot = 0.0479 kN/m<sup>2</sup>.

- Spans limited to value shown because of possible effects of concentrated loads. Allowable uniform loads based on deflection of  $\frac{1}{360}$  of span is 100 pounds per square foot except allowable total uniform load for  $1\frac{1}{8}$ -inch wood structural panels over joists spaced 48 inches on center is 65 pounds per square foot. Panel edges shall have approved tongue-and-groove joints or shall be supported with blocking, unless  $\frac{1}{4}$ -inch minimum thickness underlayment or  $1\frac{1}{2}$  inches of approved cellular or lightweight concrete is placed over the subfloor, or finish floor is  $\frac{3}{4}$ -inch wood strip.
- Floor panels conforming with this table shall be deemed to meet the design criteria of Section 2304.7.
- Applicable to all grades of sanded exterior-type plywood. See DOC PS 1 for plywood species groups.
- Applicable to Underlayment grade, C-C (Plugged) plywood, and Single Floor grade wood structural panels.



**TABLE 2304.7(5)**  
**ALLOWABLE LOAD (PSF) FOR WOOD STRUCTURAL PANEL ROOF SHEATHING CONTINUOUS**  
**OVER TWO OR MORE SPANS AND STRENGTH AXIS PARALLEL TO SUPPORTS**  
**(Plywood Structural Panels Are Five-Ply, Five-Layer Unless Otherwise Noted)<sup>a, b</sup>**

PANEL GRADE	THICKNESS (inch)	MAXIMUM SPAN (inches)	LOAD AT MAXIMUM SPAN (psf)	
			Live	Total
Structural I sheathing	$\frac{7}{16}$	24	20	30
	$\frac{15}{32}$	24	35 <sup>c</sup>	45 <sup>c</sup>
	$\frac{1}{2}$	24	40 <sup>c</sup>	50 <sup>c</sup>
	$\frac{19}{32}, \frac{5}{8}$	24	70	80
	$\frac{23}{32}, \frac{3}{4}$	24	90	100
Sheathing, other grades covered in DOC PS 1 or DOC PS 2	$\frac{7}{16}$	16	40	50
	$\frac{15}{32}$	24	20	25
	$\frac{1}{2}$	24	25	30
	$\frac{19}{32}$	24	40 <sup>c</sup>	50 <sup>c</sup>
	$\frac{5}{8}$	24	45 <sup>c</sup>	55 <sup>c</sup>
	$\frac{23}{32}, \frac{3}{4}$	24	60 <sup>c</sup>	65 <sup>c</sup>

For SI: 1 inch = 25.4 mm, 1 pound per square foot = 0.0479 kN/m<sup>2</sup>.

- Roof sheathing conforming with this table shall be deemed to meet the design criteria of Section 2304.7.
- Uniform load deflection limitations  $\frac{1}{180}$  of span under live load plus dead load,  $\frac{1}{240}$  under live load only. Edges shall be blocked with lumber or other approved type of edge supports.
- For composite and four-ply plywood structural panel, load shall be reduced by 15 pounds per square foot.

**2304.8.3.1 General.** Mechanically laminated decking consists of square-edged dimension lumber laminations set on edge and nailed to the adjacent pieces and to the supports.

**2304.8.3.2 Nailing.** The length of nails connecting laminations shall not be less than two and one-half times the net thickness of each lamination. Where decking supports are 48 inches (1219 mm) on center (o.c.) or less, side nails shall be installed not more than 30 inches (762 mm) o.c. alternating between top and bottom edges, and staggered one-third of the spacing in adjacent laminations. Where supports are spaced more than 48 inches (1219 mm) o.c., side nails shall be installed not more than 18 inches (457 mm) o.c. alternating between top and bottom edges and staggered one-third of the spacing in adjacent laminations. Two side nails shall be installed at each end of butt-jointed pieces.

Laminations shall be toenailed to supports with 20d or larger common nails. Where the supports are 48 inches (1219 mm) o.c. or less, alternate laminations shall be toenailed to alternate supports; where supports are spaced more than 48 inches (1219 mm) o.c., alternate laminations shall be toenailed to every support.

**2304.8.3.3 Controlled random pattern.** There shall be a minimum distance of 24 inches (610 mm) between end joints in adjacent courses. The pieces in the first and second courses shall bear on at least two supports with end joints in these two courses occurring on alternate supports. A maximum of seven intervening courses shall be permitted before this pattern is repeated.

**2304.8.4 Two-inch sawn tongue-and-groove decking.** Two-inch (51 mm) sawn tongue-and-groove decking shall comply with Sections 2304.8.4.1 through 2304.8.4.3.

**2304.8.4.1 General.** Two-inch (51 mm) decking shall have a maximum moisture content of 15 percent. Decking shall be machined with a single tongue-and-groove pattern. Each decking piece shall be nailed to each support.

**2304.8.4.2 Nailing.** Each piece of decking shall be toenailed at each support with one 16d common nail through the tongue and face-nailed with one 16d common nail.

**2304.8.4.3 Controlled random pattern.** There shall be a minimum distance of 24 inches (610 mm) between end joints in adjacent courses. The pieces in the first and second courses shall bear on at least two supports with end joints in these two courses occurring on alternate supports. A maximum of seven intervening courses shall be permitted before this pattern is repeated.

**2304.8.5 Three- and four-inch sawn tongue-and-groove decking.** Three- and four-inch (76 mm and 102 mm) sawn tongue-and-groove decking shall comply with Sections 2304.8.5.1 through 2304.8.5.3.

**2304.8.5.1 General.** Three-inch (76 mm) and four-inch (102 mm) decking shall have a maximum moisture content of 19 percent. Decking shall be machined with a double tongue-and-groove pattern. Decking pieces shall be interconnected and nailed to the supports.

**2304.8.5.2 Nailing.** Each piece shall be toenailed at each support with one 40d common nail and face-nailed with one 60d common nail. Courses shall be

spiked to each other with 8-inch (203 mm) spikes at maximum intervals of 30 inches (762 mm) through pre-drilled edge holes penetrating to a depth of approximately 4 inches (102 mm). One spike shall be installed at a distance not exceeding 10 inches (254 mm) from the end of each piece.

**2304.8.5.3 Controlled random pattern.** There shall be a minimum distance of 48 inches (1219 mm) between end joints in adjacent courses. Pieces not bearing on a support are permitted to be located in interior bays provided the adjacent pieces in the same course continue over the support for at least 24 inches (610 mm). This condition shall not occur more than once in every six courses in each interior bay.

**2304.9 Connectors and fasteners.** Connectors and fasteners shall comply with the applicable provisions of Sections 2304.9.1 through 2304.9.7.

**2304.9.1 Fastener requirements.** Connections for wood members shall be designed in accordance with the appropriate methodology in Section 2301.2. The number and size of fasteners connecting wood members shall not be less than that set forth in Table 2304.9.1.

**2304.9.2 Sheathing fasteners.** Sheathing nails or other *approved* sheathing connectors shall be driven so that their head or crown is flush with the surface of the sheathing.

**2304.9.3 Joist hangers and framing anchors.** Connections depending on joist hangers or framing anchors, ties and other mechanical fastenings not otherwise covered are permitted where *approved*. The vertical load-bearing capacity, torsional moment capacity and deflection characteristics of joist hangers shall be determined in accordance with Section 1711.1.

**2304.9.4 Other fasteners.** Clips, staples, glues and other *approved* methods of fastening are permitted where *approved*.

**2304.9.5 Fasteners and connectors in contact with preservative-treated and fire-retardant-treated wood.** Fasteners, including nuts and washers, and connectors in contact with *preservative-treated* and *fire-retardant-treated wood* shall be in accordance with Sections 2304.9.5.1 through 2304.9.5.4. The coating weights for zinc-coated fasteners shall be in accordance with ASTM A 153.

**2304.9.5.1 Fasteners and connectors for preservative-treated wood.** Fasteners, including nuts and washers, in contact with *preservative-treated wood* shall be of hot-dipped zinc-coated galvanized steel, stainless steel, silicon bronze or copper. Fasteners other than nails, timber rivets, wood screws and lag screws shall be permitted to be of mechanically deposited zinc-coated steel with coating weights in accordance with ASTM B 695, Class 55 minimum. Connectors that are used in exterior applications and in contact with *preservative-treated wood* shall have coating types and weights in accordance with the treated wood or connec-

tor manufacturer's recommendations. In the absence of manufacturer's recommendations, a minimum of ASTM A 653, type G185 zinc-coated galvanized steel, or equivalent, shall be used.

**Exception:** Plain carbon steel fasteners, including nuts and washers, in SBX/DOT and zinc borate *preservative-treated wood* in an interior, dry environment shall be permitted.

**2304.9.5.2 Fastenings for wood foundations.** Fastenings, including nuts and washers, for wood foundations shall be as required in AF&PA PWF.

**2304.9.5.3 Fasteners for fire-retardant-treated wood used in exterior applications or wet or damp locations.** Fasteners, including nuts and washers, for *fire-retardant-treated wood* used in exterior applications or wet or damp locations shall be of hot-dipped zinc-coated galvanized steel, stainless steel, silicon bronze or copper. Fasteners other than nails, timber rivets, wood screws and lag screws shall be permitted to be of mechanically deposited zinc-coated steel with coating weights in accordance with ASTM B 695, Class 55 minimum.

**2304.9.5.4 Fasteners for fire-retardant-treated wood used in interior applications.** Fasteners, including nuts and washers, for *fire-retardant-treated wood* used in interior locations shall be in accordance with the manufacturer's recommendations. In the absence of manufacturer's recommendations, Section 2304.9.5.3 shall apply.

**2304.9.6 Load path.** Where wall framing members are not continuous from foundation sill to roof, the members shall be secured to ensure a continuous load path. Where required, sheet metal clamps, ties or clips shall be formed of galvanized steel or other *approved* corrosion-resistant material not less than 0.040 inch (1.01 mm) nominal thickness.

**2304.9.7 Framing requirements.** Wood columns and posts shall be framed to provide full end bearing. Alternatively, column-and-post end connections shall be designed to resist the full compressive loads, neglecting end-bearing capacity. Column-and-post end connections shall be fastened to resist lateral and net induced uplift forces.

**2304.10 Heavy timber construction.** Where a structure or portion thereof is required to be of Type IV construction by other provisions of this code, the building elements therein shall comply with the applicable provisions of Sections 2304.10.1 through 2304.10.5.

**2304.10.1 Columns.** Columns shall be continuous or superimposed throughout all stories by means of reinforced concrete or metal caps with brackets, or shall be connected by properly designed steel or iron caps, with pintles and base plates, or by timber splice plates affixed to the columns by metal connectors housed within the contact faces, or by other *approved* methods.

**TABLE 2304.9.1  
FASTENING SCHEDULE**

DESCRIPTION OF BUILDING ELEMENTS		NUMBER AND TYPE OF FASTENER <sup>a, b, c</sup>	SPACING
<b>Roof</b>			
1	Blocking between ceiling joists or rafters to top plate or other framing below	3 - 8d common (2 <sup>1</sup> / <sub>2</sub> " × 0.131"); or 3 - 10d box (3" × 0.128"); or 3 - 3" × 0.131" nails; or 3 - 3" 14 gage staples, <sup>7</sup> / <sub>16</sub> " crown	At each end, toe nail
	Flat-blocking to truss and web filler	16d common (3 <sup>1</sup> / <sub>2</sub> " × 0.162") at 16" o.c.; or 3" × 0.131" nails at 6" o.c.; or 3" × 14 gage staples, <sup>7</sup> / <sub>16</sub> " crown at 6" o.c.	Face nail
2	Ceiling joists to top plate	3 - 8d common (2 <sup>1</sup> / <sub>2</sub> " × 0.131"); or 3 - 10d box (3" × 0.128"); or 3 - 3" × 0.131" nails; or 3 - 3" 14 gage staples, <sup>7</sup> / <sub>16</sub> " crown	Per joist, toe nail
3	Ceiling joist not attached to parallel rafter (no thrust), laps over partitions (see Section 2308.10.4.1 and Table 2308.10.4.1)	3 - 16d common (3 <sup>1</sup> / <sub>2</sub> " × 0.162"); or 4 - 10d box (3" × 0.128"); or 4 - 3" × 0.131" nails; or 4 - 3" 14 gage staples, <sup>7</sup> / <sub>16</sub> " crown	Face nail
4	Ceiling joist attached to parallel rafter (heel joint) (see Section 2308.10.4.1 and Table 2308.10.4.1)	Per Table 2308.10.4.1	Face nail
5	Collar tie to rafter	3 - 10d common (3" × 0.148"); or 4 - 10d box (3" × 0.128"); or 4 - 3" × 0.131" nails; or 4 - 3" 14 gage staples, <sup>7</sup> / <sub>16</sub> " crown	Face nail
6	Rafter or roof truss to plate or other framing below (see Section 2308.10.1 and Table 2308.10.1)	3 - 10d common (3" × 0.148"); or 3 - 16d box (3 <sup>1</sup> / <sub>2</sub> " × 0.135"); or 4 - 10d box (3" × 0.128"); or 4 - 3" × 0.131" nails; or 4 - 3" 14 gage staples, <sup>7</sup> / <sub>16</sub> " crown	Toenail <sup>e</sup>
7	Roof rafters to ridge, valley or hip rafters; or, roof rafter to 2-inch ridge board	2 - 16d common (3 <sup>1</sup> / <sub>2</sub> " × 0.162"); or 3 - 10d box (3" × 0.128"); or 3 - 3" × 0.131" nails; or 3 - 3" 14 gage staples, <sup>7</sup> / <sub>16</sub> " crown	End nail
		2 - 16d box (3 <sup>1</sup> / <sub>2</sub> " × 0.135"); or 3 - 10d common (3" × 0.148"); or 3 - 16d box (3 <sup>1</sup> / <sub>2</sub> " × 0.135"); or 4 - 10d box (3" × 0.128"); or 4 - 3" × 0.131" nails; or 4 - 3" 14 gage staples, <sup>7</sup> / <sub>16</sub> " crown	Toe nail

*(continued)*

**TABLE 2304.9.1—continued  
FASTENING SCHEDULE**

DESCRIPTION OF BUILDING ELEMENTS		NUMBER AND TYPE OF FASTENER <sup>a,b,c</sup>	SPACING
<b>Walls</b>			
8	Stud to stud (not at braced wall panels)	16d common (3 <sup>1</sup> / <sub>2</sub> " × 0.162"); or	24" o.c. face nail
		10d box (3" × 0.128"); or 3" × 0.131" nails; or 3 - 3" 14 gage staples, 7/16" crown	16" o.c. face nail
9	Stud to stud and abutting studs at intersecting wall corners (at braced wall panels)	16d common (3 <sup>1</sup> / <sub>2</sub> " × 0.162"); or	16" o.c. face nail
		16d box (3 <sup>1</sup> / <sub>2</sub> " × 0.135"); or 3" × 0.131" nails; or 3 - 3" 14 gage staples, 7/16" crown	12" o.c. face nail
10	Built-up header (2-inch to 2-inch header)	16d common (3 <sup>1</sup> / <sub>2</sub> " × 0.162"); or	16" o.c. each edge face nail
		16d box (3 <sup>1</sup> / <sub>2</sub> " × 0.135")	12" o.c. each edge face nail
11	Continuous header to stud	4 - 8d common (2 <sup>1</sup> / <sub>2</sub> " × 0.131"); or 4 - 10d box (3" × 0.128")	Toe nail
12	Top plate to top plate	16d common (3 <sup>1</sup> / <sub>2</sub> " × 0.162"); or	16" o.c. face nail
		10d box (3" × 0.128"); or 3" × 0.131" nails; or 3" 14 gage staples, 7/16" crown	12" o.c. face nail
13	Top plate to top plate, at end joints	8 - 16d common (3 <sup>1</sup> / <sub>2</sub> " × 0.162"); or 12 - 10d box (3" × 0.128"); or 12 - 3" × 0.131" nails; or 12 - 3" 14 gage staples, 7/16" crown	Face nail on each side of end joint (minimum 24" lap splice length each side of end joint)
14	Bottom plate to joist, rim joist, band joist, blocking (not at braced wall panels)	16d common (3 <sup>1</sup> / <sub>2</sub> " × 0.162")	16" o.c. face nail
		16d box (3 <sup>1</sup> / <sub>2</sub> " × 0.135"); or 3" × 0.131" nails; or 3" 14 gage staples, 7/16" crown	12" o.c. face nail
15	Bottom plate to joist, rim joist, band joist or blocking at braced wall panels	2 - 16d common (3 <sup>1</sup> / <sub>2</sub> " × 0.162"); or 3 - 16d box (3 <sup>1</sup> / <sub>2</sub> " × 0.135"); or 4 - 3" × 0.131" nails; or 4 - 3" 14 gage staples, 7/16" crown	16" o.c. face nail
16	Stud to bottom plate	4 - 8d common (2 <sup>1</sup> / <sub>2</sub> " × 0.131"); or 4 - 10d box (3" × 0.128"); or 4 - 3" × 0.131" nails; or 4 - 3" 14 gage staples, 7/16" crown; or	Toe nail
		2 - 16d common (3 <sup>1</sup> / <sub>2</sub> " × 0.162"); or 3 - 10d box (3" × 0.128"); or 3 - 3" × 0.131" nails; or 3 - 3" 14 gage staples, 7/16" crown	End nail
17	Top or bottom plate to stud	2 - 16d common (3 <sup>1</sup> / <sub>2</sub> " × 0.162"); or 3 - 10d box (3" × 0.128"); or 3 - 3" × 0.131" nails; or 3 - 3" 14 gage staples, 7/16" crown	End nail
18	Top plates, laps at corners and intersections	2 - 16d common (3 <sup>1</sup> / <sub>2</sub> " × 0.162"); or 3 - 10d box (3" × 0.128"); or 3 - 3" × 0.131" nails; or 3 - 3" 14 gage staples, 7/16" crown	Face nail
19	1" brace to each stud and plate	2 - 8d common (2 <sup>1</sup> / <sub>2</sub> " × 0.131"); or 2 - 10d box (3" × 0.128"); or 2 - 3" × 0.131" nails; or 2 - 3" 14 gage staples, 7/16" crown	Face nail
20	1" × 6" sheathing to each bearing	2 - 8d common (2 <sup>1</sup> / <sub>2</sub> " × 0.131"); or 2 - 10d box (3" × 0.128")	Face nail
21	1" × 8" and wider sheathing to each bearing	3 - 8d common (2 <sup>1</sup> / <sub>2</sub> " × 0.131"); or 3 - 10d box (3" × 0.128")	Face nail

(continued)

**TABLE 2304.9.1—continued  
FASTENING SCHEDULE**

DESCRIPTION OF BUILDING ELEMENTS		NUMBER AND TYPE OF FASTENER <sup>a, b, c</sup>	SPACING
<b>Floor</b>			
22	Joist to sill, top plate, or girder	3 - 8d common (2½" × 0.131"); or 3 - 10d box (3" × 0.128"); or 3 - 3" × 0.131" nails; or 3 - 3" 14 gage staples, 7/16" crown	Toe nail
23	Rim joist, band joist, or blocking to sill, top plate or other framing below	8d common (2½" × 0.131"); or 10d box (3" × 0.128"); or 3" × 0.131" nails; or 3" 14 gage staples, 7/16" crown	6" o.c. toe nail
24	1" × 6" subfloor or less to each joist	2 - 8d common (2½" × 0.131"); or 2 - 10d box (3" × 0.128")	Face nail
25	2" subfloor to joist or girder	2 - 16d common (3½" × 0.162")	Blind and face nail
26	2" planks (plank & beam - floor & roof)	2 - 16d common (3½" × 0.162")	At each bearing, face nail
27	Built-up girders and beams, 2-inch lumber layers	20d common (4" × 0.192")	32" o.c. face nail at top and bottom staggered on opposite sides
		10d box (3" × 0.128"); or 3" × 0.131" nails; or 3" 14 gage staples, 7/16" crown	24" o.c. face nail at top and bottom staggered on opposite sides
		And: 2 - 20d common (4" × 0.192"); or 3 - 10d box (3" × 0.128"); or 3 - 3" × 0.131" nails; or 3 - 3" 14 gage staples, 7/16" crown	Face nail at ends and at each splice
28	Ledger strip supporting joists or rafters	3 - 16d common (3½" × 0.162"); or 4 - 10d box (3" × 0.128"); or 4 - 3" × 0.131" nails; or 4 - 3" 14 gage staples, 7/16" crown	At each joist or rafter, face nail
29	Joist to band joist or rim joist	3 - 16d common (3½" × 0.162"); or 4 - 10d box (3" × 0.128"); or 4 - 3" × 0.131" nails; or 4 - 3" 14 gage staples, 7/16" crown	End nail
30	Bridging to joist	2 - 8d common (2½" × 0.131"); or 2 - 10d box (3" × 0.128") 2 - 3" × 0.131" nails; or 2 - 3" 14 gage staples, 7/16" crown	Each end, toenail

(continued)

**TABLE 2304.9.1—continued  
FASTENING SCHEDULE**

ITEM	DESCRIPTION OF BUILDING MATERIALS	DESCRIPTION OF FASTENER <sup>a, b, c</sup>	SPACING OF FASTENERS	
			EDGES (inches)	INTERMEDIATE SUPPORTS (inches)
<b>Wood structural panels, subfloor, roof and interior wall sheathing to framing and particleboard wall sheathing to framing</b>				
31	$\frac{3}{8}$ " - $\frac{1}{2}$ "	6d common or deformed ( $2" \times 0.113"$ ) (subfloor and wall)	6	12
		8d box or deformed ( $2\frac{1}{2}" \times 0.113"$ )	6	12
		$2\frac{3}{8}" \times 0.113"$ nail (subfloor and wall)	6	12
		$1\frac{3}{4}"$ 16 gage staple, $\frac{7}{16}"$ crown (subfloor and wall)	4	8
		$2\frac{3}{8}" \times 0.113"$ nail (roof)	4	8
		$1\frac{3}{4}"$ 16 gage staple, $\frac{7}{16}"$ crown (roof)	3	6
32	$1\frac{9}{32}"$ - $\frac{3}{4}"$	8d common ( $2\frac{1}{2}" \times 0.131"$ ); or 6d deformed ( $2" \times 0.113"$ )	6	12
		$2\frac{3}{8}" \times 0.113"$ nail; or 2" 16 gage staple, $\frac{7}{16}"$ crown	4	8
33	$\frac{7}{8}"$ - $1\frac{1}{4}"$	10d common ( $3" \times 0.148"$ ) nail; or 8d ( $2\frac{1}{2}" \times 0.131"$ ) deformed nail	6	12
<b>Other exterior wall sheathing<sup>b</sup></b>				
34	$\frac{1}{2}"$ fiberboard sheathing <sup>b</sup>	$1\frac{1}{2}"$ galvanized roofing nail, $\frac{7}{16}"$ head diameter; or $1\frac{1}{4}"$ 16 gage staple, $\frac{7}{16}"$ or 1" crown	3	6
35	$2\frac{5}{32}"$ fiberboard sheathing <sup>b</sup>	$1\frac{3}{4}"$ galvanized roofing nail, $\frac{7}{16}"$ head diameter; or $1\frac{1}{2}"$ 16 gage staple, $\frac{7}{16}"$ or 1" crown	3	6
<b>Wood structural panels, combination subfloor underlayment to framing</b>				
36	$\frac{3}{4}"$ and less	8d common ( $2\frac{1}{2}" \times 0.131"$ ); or 6d deformed ( $2" \times 0.113"$ )	6	1 2
37	$\frac{7}{8}"$ - 1"	8d common ( $2\frac{1}{2}" \times 0.131"$ ); or 8d deformed ( $2\frac{1}{2}" \times 0.120"$ ) nail	6	1 2
38	$1\frac{1}{8}"$ - $1\frac{1}{4}"$	10d common ( $3" \times 0.148"$ ); or 8d deformed ( $2\frac{1}{2}" \times 0.131"$ ) nail	6	1 2
<b>Panel siding to framing</b>				
39	$\frac{1}{2}"$ or less	6d corrosion-resistant siding ( $1\frac{7}{8}" \times 0.106"$ ); or 6d corrosion-resistant casing	6	1 2
40	$\frac{5}{8}"$	8d corrosion-resistant siding ( $2\frac{3}{8}" \times 0.128"$ ); or 8d corrosion-resistant casing	6	1 2
<b>Interior paneling</b>				
41	$\frac{1}{4}"$	4d casing ( $1\frac{1}{2}" \times 0.080"$ ); or 4d finish ( $1\frac{1}{2}" \times 0.072"$ )	6	1 2
42	$\frac{3}{8}"$	6d casing ( $1" \times 0.099"$ ); or 6d finish (panel supports at 24")	6	1 2

For SI: 1 inch = 25.4 mm, 1 foot = 304.8 mm, 1 mile per hour = 0.447 m/s; 1 Ksi = 6.895 MPa.

- a. Nails spaced at 6 inches at intermediate supports where spans are 48 inches or more. For nailing of wood structural panel and particleboard diaphragms and shear walls, refer to Section 2305. Nails for wall sheathing are permitted to be common, box or casing.
- b. Spacing shall be 6 inches on center on the edges and 12 inches on center at intermediate supports for nonstructural applications. Panel supports at 16 inches (20 inches if strength axis in the long direction of the panel, unless otherwise marked).
- c. Where a rafter is fastened to an adjacent parallel ceiling joist in accordance with this schedule and the ceiling joist is fastened to the top plate in accordance with this schedule, the number of toenails in the rafter shall be permitted to be reduced by one nail.

**2304.10.1.1 Column connections.** Girders and beams shall be closely fitted around columns and adjoining ends shall be cross tied to each other, or intertied by caps or ties, to transfer horizontal loads across joints. Wood bolsters shall not be placed on tops of columns unless the columns support roof loads only.

**2304.10.2 Floor framing.** *Approved* wall plate boxes or hangers shall be provided where wood beams, girders or trusses rest on masonry or concrete walls. Where intermediate beams are used to support a floor, they shall rest on top of girders, or shall be supported by ledgers or blocks securely fastened to the sides of the girders, or they shall be supported by an *approved* metal hanger into which the ends of the beams shall be closely fitted.

**2304.10.3 Roof framing.** Every roof girder and at least every alternate roof beam shall be anchored to its supporting member; and every monitor and every sawtooth construction shall be anchored to the main roof construction. Such anchors shall consist of steel or iron bolts of sufficient strength to resist vertical uplift of the roof.

**2304.10.4 Floor decks.** Floor decks and covering shall not extend closer than  $\frac{1}{2}$  inch (12.7 mm) to walls. Such  $\frac{1}{2}$ -inch (12.7 mm) spaces shall be covered by a molding fastened to the wall either above or below the floor and arranged such that the molding will not obstruct the expansion or contraction movements of the floor. Corbeling of masonry walls under floors is permitted in place of such molding.

**2304.10.5 Roof decks.** Where supported by a wall, roof decks shall be anchored to walls to resist uplift forces determined in accordance with Chapter 16. Such anchors shall consist of steel or iron bolts of sufficient strength to resist vertical uplift of the roof.

**2304.11 Protection against decay and termites.** Wood shall be protected from decay and termites in accordance with the applicable provisions of Sections 2304.11.1 through 2304.11.9.

**2304.11.1 General.** Where required by this section, protection from decay and termites shall be provided by the use of naturally durable or *preservative-treated wood*.

**2304.11.2 Wood used above ground.** Wood used above ground in the locations specified in Sections 2304.11.2.1 through 2304.11.2.7, 2304.11.3 and 2304.11.5 shall be naturally durable wood or *preservative-treated wood* using water-borne preservatives, in accordance with AWPA U1 (Commodity Specifications A or F) for above-ground use.

**2304.11.2.1 Joists, girders and subfloor.** Where wood joists or the bottom of a wood structural floor without joists are closer than 18 inches (457 mm), or wood girders are closer than 12 inches (305 mm) to the exposed ground in crawl spaces or unexcavated areas located within the perimeter of the building foundation, the floor construction (including posts, girders, joists and subfloor) shall be of naturally durable or *preservative-treated wood*.

**2304.11.2.2 Wood supported by exterior foundation walls.** Wood framing members, including wood sheathing, that rest on exterior foundation walls and are less than 8 inches (203 mm) from exposed earth shall be of naturally durable or *preservative-treated wood*.

**2304.11.2.3 Exterior walls below grade.** Wood framing members and furring strips attached directly to the interior of exterior masonry or concrete walls below grade shall be of naturally durable or *preservative-treated wood*.

**2304.11.2.4 Sleepers and sills.** Sleepers and sills on a concrete or masonry slab that is in direct contact with earth shall be of naturally durable or *preservative-treated wood*.

**2304.11.2.5 Girder ends.** The ends of wood girders entering exterior masonry or concrete walls shall be provided with a  $\frac{1}{2}$ -inch (12.7 mm) air space on top, sides and end, unless naturally durable or *preservative-treated wood* is used.

**2304.11.2.6 Wood siding.** Clearance between wood siding and earth on the exterior of a building shall not be less than 6 inches (152 mm) or less than 2 inches (51 mm) vertical from concrete steps, porch slabs, patio slabs and similar horizontal surfaces exposed to the weather except where siding, sheathing and wall framing are of naturally durable or *preservative-treated wood*.

**2304.11.2.7 Posts or columns.** Posts or columns supporting permanent structures and supported by a concrete or masonry slab or footing that is in direct contact with the earth shall be of naturally durable or *preservative-treated wood*.

**Exceptions:**

1. Posts or columns that are either exposed to the weather or located in basements or cellars, supported by concrete piers or metal pedestals projected at least 1 inch (25 mm) above the slab or deck and 6 inches (152 mm) above exposed earth, and are separated therefrom by an impervious moisture barrier.
2. Posts or columns in enclosed crawl spaces or unexcavated areas located within the periphery of the building, supported by a concrete pier or metal pedestal at a height greater than 8 inches (203 mm) from exposed ground, and are separated therefrom by an impervious moisture barrier.

**2304.11.3 Laminated timbers.** The portions of glued-laminated timbers that form the structural supports of a building or other structure and are exposed to weather and not fully protected from moisture by a roof, eave or similar covering shall be pressure treated with preservative or be manufactured from naturally durable or *preservative-treated wood*.

**2304.11.4 Wood in contact with the ground or fresh water.** Wood used in contact with the ground (exposed earth) in the locations specified in Sections 2304.11.4.1 and 2304.11.4.2 shall be naturally durable (species for both decay and termite resistance) or preservative treated using water-borne preservatives in accordance with AWWA U1 (Commodity Specifications A or F) for soil or fresh water use.

**Exception:** Untreated wood is permitted where such wood is continuously and entirely below the ground-water level or submerged in fresh water.

**2304.11.4.1 Posts or columns.** Posts and columns supporting permanent structures that are embedded in concrete that is in direct contact with the earth, embedded in concrete that is exposed to the weather or in direct contact with the earth shall be of *preservative-treated wood*.

**2304.11.4.2 Wood structural members.** Wood structural members that support moisture-permeable floors or roofs that are exposed to the weather, such as concrete or masonry slabs, shall be of naturally durable or *preservative-treated wood* unless separated from such floors or roofs by an impervious moisture barrier.

**2304.11.5 Supporting member for permanent appurtenances.** Naturally durable or *preservative-treated wood* shall be utilized for those portions of wood members that form the structural supports of buildings, balconies, porches or similar permanent building appurtenances where such members are exposed to the weather without adequate protection from a roof, eave, overhang or other covering to prevent moisture or water accumulation on the surface or at joints between members.

**Exception:** When a building is located in a geographical region where experience has demonstrated that climatic conditions preclude the need to use durable materials where the structure is exposed to the weather.

**2304.11.6 Termite protection.** In geographical areas where hazard of termite damage is known to be very heavy, wood floor framing in the locations specified in Section 2304.11.2.1 and exposed framing of exterior decks or balconies shall be of naturally durable species (termite resistant) or preservative treated in accordance with AWWA U1 for the species, product preservative and end use or provided with *approved* methods of termite protection.

**2304.11.7 Wood used in retaining walls and cribs.** Wood installed in retaining or crib walls shall be preservative treated in accordance with AWWA U1 (Commodity Specifications A or F) for soil and fresh water use.

**2304.11.8 Attic ventilation.** For *attic* ventilation, see Section 1203.2.

**2304.11.9 Under-floor ventilation (crawl space).** For under-floor ventilation (crawl space), see Section 1203.3.

**2304.12 Long-term loading.** Wood members supporting concrete, masonry or similar materials shall be checked for the effects of long-term loading using the provisions of the

AF&PA NDS. The total deflection, including the effects of long-term loading, shall be limited in accordance with Section 1604.3.1 for these supported materials.

**Exception:** Horizontal wood members supporting masonry or concrete nonstructural floor or roof surfacing not more than 4 inches (102 mm) thick need not be checked for long-term loading.

## SECTION 2305 GENERAL DESIGN REQUIREMENTS FOR LATERAL FORCE-RESISTING SYSTEMS

**2305.1 General.** Structures using wood-frame shear walls or wood-frame diaphragms to resist wind, seismic or other lateral loads shall be designed and constructed in accordance with AF&PA SDPWS and the applicable provisions of Sections 2305, 2306 and 2307.

**2305.1.1 Openings in shear panels.** Openings in shear panels that materially affect their strength shall be detailed on the plans, and shall have their edges adequately reinforced to transfer all shearing stresses.

**2305.2 Diaphragm deflection.** The deflection of wood-frame diaphragms shall be determined in accordance with AF&PA SDPWS. The deflection ( $\Delta$ ) of a blocked wood structural panel diaphragm uniformly fastened throughout with staples is permitted to be calculated in accordance with Equation 23-1. If not uniformly fastened, the constant 0.188 (For SI: 1/1627) in the third term shall be modified by an approved method.

$$\Delta = \frac{5vL^3}{8EAb} + \frac{vL}{4Gt} + 0.122Le_n + \frac{\Sigma(\Delta_c X)}{2b} \quad (\text{Equation 23-1})$$

$$\text{For SI: } \Delta = \frac{0.052vL^3}{EAb} + \frac{vL}{4Gt} + \frac{Le_n}{1627} + \frac{\Sigma(\Delta_c X)}{2b}$$

where:

- $A$  = Area of chord cross section, in square inches ( $\text{mm}^2$ ).
- $b$  = Diaphragm width, in feet (mm).
- $E$  = Elastic modulus of chords, in pounds per square inch (N/ $\text{mm}^2$ ).
- $e_n$  = Staple deformation, in inches (mm) [see Table 2305.2(1)].
- $Gt$  = Panel rigidity through the thickness, in pounds per inch (N/mm) of panel width or depth [see Table 2305.2(2)].
- $L$  = Diaphragm length, in feet (mm).
- $v$  = Maximum shear due to design loads in the direction under consideration, in pounds per linear foot (plf) (N/mm).
- $\Delta$  = The calculated deflection, in inches (mm).
- $\Sigma(\Delta_c X)$  = Sum of individual chord-splice slip values on both sides of the diaphragm, each multiplied by its distance to the nearest support.



**TABLE 2305.2(1)**  
 **$e_n$  VALUES (inches) FOR USE IN CALCULATING DIAPHRAGM AND SHEAR WALL DEFLECTION DUE TO FASTENER SLIP (Structural I)<sup>a, c</sup>**

LOAD PER FASTENER <sup>b</sup> (pounds)	FASTENER DESIGNATIONS
	14-Ga staple x 2 inches long
60	0.011
80	0.018
100	0.028
120	0.04
140	0.053
160	0.068

For SI: 1 inch = 25.4 mm, 1 foot = 304.8 mm, 1 pound = 4.448 N.

- a. Increase  $e_n$  values 20 percent for plywood grades other than Structural I.
- b. Load per fastener = maximum shear per foot divided by the number of fasteners per foot at interior panel edges.
- c. Decrease  $e_n$  values 50 percent for seasoned lumber (moisture content < 19 percent).

**2305.3 Shear wall deflection.** The deflection of wood-frame shear walls shall be determined in accordance with AF&PA

SDPWS. The deflection ( $\Delta$ ) of a blocked wood structural panel shear wall uniformly fastened throughout with staples is permitted to be calculated in accordance with Equation 23-2.

$$\Delta = \frac{8vh^3}{EAb} + \frac{vh}{Gt} + 0.75he_n + d_a \frac{h}{b} \quad \text{(Equation 23-2)}$$

$$\text{For SI: } \Delta = \frac{vh^3}{3EAb} + \frac{vh}{Gt} + \frac{he_n}{407.6} + d_a \frac{h}{b}$$

where:

$A$  = Area of boundary element cross section in square inches (mm<sup>2</sup>) (vertical member at shear wall boundary).

$b$  = Wall width, in feet (mm).

$d_a$  = Vertical elongation of overturning anchorage (including fastener slip, device elongation, anchor rod elongation, etc.) at the design shear load ( $v$ ).

**TABLE 2305.2(2)**  
**VALUES OF  $Gt$  FOR USE IN CALCULATING DEFLECTION OF WOOD STRUCTURAL PANEL SHEAR WALLS AND DIAPHRAGMS**

PANEL TYPE	SPAN RATING	VALUES OF $Gt$ (lb/in. panel depth or width)							
		OTHER				STRUCTURAL I			
		3-ply Plywood	4-ply Plywood	5-ply Plywood <sup>a</sup>	OSB	3-ply Plywood	4-ply Plywood	5-ply Plywood <sup>a</sup>	OSB
Sheathing	24/0	25,000	32,500	37,500	77,500	32,500	42,500	41,500	77,500
	24/16	27,000	35,000	40,500	83,500	35,000	45,500	44,500	83,500
	32/16	27,000	35,000	40,500	83,500	35,000	45,500	44,500	83,500
	40/20	28,500	37,000	43,000	88,500	37,000	48,000	47,500	88,500
	48/24	31,000	40,500	46,500	96,000	40,500	52,500	51,000	96,000
Single Floor	16 o.c.	27,000	35,000	40,500	83,500	35,000	45,500	44,500	83,500
	20 o.c.	28,000	36,500	42,000	87,000	36,500	47,500	46,000	87,000
	24 o.c.	30,000	39,000	45,000	93,000	39,000	50,500	49,500	93,000
	32 o.c.	36,000	47,000	54,000	110,000	47,000	61,000	59,500	110,000
	48 o.c.	50,500	65,500	76,000	155,000	65,500	85,000	83,500	155,000

	Thickness (in.)	OTHER			STRUCTURAL I		
		A-A, A-C	Marine	All Other Grades	A-A, A-C	Marine	All Other Grades
Sanded Plywood	1/4	24,000	31,000	24,000	31,000	31,000	31,000
	11/32	25,500	33,000	25,500	33,000	33,000	33,000
	3/8	26,000	34,000	26,000	34,000	34,000	34,000
	15/32	38,000	49,500	38,000	49,500	49,500	49,500
	1/2	38,500	50,000	38,500	50,000	50,000	50,000
	19/32	49,000	63,500	49,000	63,500	63,500	63,500
	5/8	49,500	64,500	49,500	64,500	64,500	64,500
	23/32	50,500	65,500	50,500	65,500	65,500	65,500
	3/4	51,000	66,500	51,000	66,500	66,500	66,500
	7/8	52,500	68,500	52,500	68,500	68,500	68,500
	1	73,500	95,500	73,500	95,500	95,500	95,500
1 1/8	75,000	97,500	75,000	97,500	97,500	97,500	

For SI: 1 inch = 25.4 mm, 1 pound/inch = 0.1751 N/mm.

- a. Applies to plywood with five or more layers; for five-ply/three-layer plywood, use values for four ply.

## WOOD

$E$  = Elastic modulus of boundary element (vertical member at shear wall boundary), in pounds per square inch (N/mm<sup>2</sup>).

$e_n$  = Staple deformation, in inches (mm) [see Table 2305.2(1)].

$Gt$  = Panel rigidity through the thickness, in pounds per inch (N/mm) of panel width or depth [see Table 2305.2(2)].

$h$  = Wall height, in feet (mm).

$v$  = Maximum shear due to design loads at the top of the wall, in pounds per linear foot (N/mm).

$\Delta$  = The calculated deflection, in inches (mm).

### SECTION 2306 ALLOWABLE STRESS DESIGN

**2306.1 Allowable stress design.** The design and construction of wood elements in structures using *allowable stress design* shall be in accordance with the following applicable standards:

#### American Forest & Paper Association.

NDS National Design Specification for Wood Construction

SDPWS Special Design Provisions for Wind and Seismic

#### American Institute of Timber Construction.

AITC 104 Typical Construction Details

AITC 110 Standard Appearance Grades for Structural Glued Laminated Timber

AITC 113 Standard for Dimensions of Structural Glued Laminated Timber

AITC 117 Standard Specifications for Structural Glued Laminated Timber of Softwood Species

AITC 119 Standard Specifications for Structural Glued Laminated Timber of Hardwood Species

ANSI/AITC A190.1 Structural Glued Laminated Timber

AITC 200 Inspection Manual

#### American Society of Agricultural and Biological Engineers.

ASABE EP 484.2 Diaphragm Design of Metal-clad, Post-Frame Rectangular Buildings

ASABE EP 486.1 Shallow Post Foundation Design

ASABE 559 Design Requirements and Bending Properties for Mechanically Laminated Columns

#### APA—The Engineered Wood Association.

Panel Design Specification

Plywood Design Specification Supplement 1—  
Design & Fabrication of Plywood Curved Panel

Plywood Design Specification Supplement 2—  
Design & Fabrication of Glued Plywood-lumber Beams

Plywood Design Specification Supplement 3—  
Design & Fabrication of Plywood Stressed-skin Panels

Plywood Design Specification Supplement 4—  
Design & Fabrication of Plywood Sandwich Panels

Plywood Design Specification Supplement 5—  
Design & Fabrication of All-plywood Beams

EWS T300 Glulam Connection Details

EWS S560 Field Notching and Drilling of Glued Laminated Timber Beams

EWS S475 Glued Laminated Beam Design Tables

EWS X450 Glulam in Residential Construction

EWS X440 Product and Application Guide: Glulam

EWS R540 Builders Tips: Proper Storage and Handling of Glulam Beams

#### Truss Plate Institute, Inc.

TPI 1 National Design Standard for Metal Plate Connected Wood Truss Construction

**2306.1.1 Joists and rafters.** The design of rafter spans is permitted to be in accordance with the *AF&PA Span Tables for Joists and Rafters*.

**2306.1.2 Plank and beam flooring.** The design of plank and beam flooring is permitted to be in accordance with the *AF&PA Wood Construction Data No. 4*.

**2306.1.3 Treated wood stress adjustments.** The allowable unit stresses for *preservative-treated wood* need no adjustment for treatment, but are subject to other adjustments.

The allowable unit stresses for *fire-retardant-treated wood*, including fastener values, shall be developed from an *approved* method of investigation that considers the effects of anticipated temperature and humidity to which the *fire-retardant-treated wood* will be subjected, the type of treatment and the redrying process. Other adjustments are applicable except that the impact load duration shall not apply.

**2306.1.4 Lumber decking.** The capacity of lumber decking arranged according to the patterns described in Section 2304.8.2 shall be the lesser of the capacities determined for flexure and deflection according to the formulas in Table 2306.1.4.

**2306.2 Wood-frame diaphragms.** Wood-frame diaphragms shall be designed and constructed in accordance with AF&PA SDPWS. Where panels are fastened to framing members with staples, requirements and limitations of AF&PA SDPWS shall be met and the allowable shear values set forth in Table 2306.2(1) or 2306.2(2) shall be permitted. The allowable shear values in Tables 2306.2(1) and 2306.2(2) are permitted to be increased 40 percent for wind design.

**2306.2.1 Gypsum board diaphragm ceilings.** Gypsum board diaphragm ceilings shall be in accordance with Section 2508.5.

**TABLE 2306.1.4  
ALLOWABLE LOADS FOR LUMBER DECKING**

PATTERN	ALLOWABLE AREA LOAD <sup>a, b</sup>	
	Flexure	Deflection
Simple span	$\sigma_b = \frac{8F'_b d^2}{l^2 6}$	$\sigma_\Delta = \frac{384\Delta E' d^3}{5l^4 12}$
Two-span continuous	$\sigma_b = \frac{8F'_b d^2}{l^2 6}$	$\sigma_\Delta = \frac{185\Delta E' d^3}{l^4 12}$
Combination simple- and two-span continuous	$\sigma_b = \frac{8F'_b d^2}{l^2 6}$	$\sigma_\Delta = \frac{131\Delta E' d^3}{l^4 12}$
Cantilevered pieces intermixed	$\sigma_b = \frac{20F'_b d^2}{3l^2 6}$	$\sigma_\Delta = \frac{105\Delta E' d^3}{l^4 12}$
<b>Controlled random layup</b>		
Mechanically laminated decking	$\sigma_b = \frac{20F'_b d^2}{3l^2 6}$	$\sigma_\Delta = \frac{100\Delta E' d^3}{l^4 12}$
2-inch decking	$\sigma_b = \frac{20F'_b d^2}{3l^2 6}$	$\sigma_\Delta = \frac{100\Delta E' d^3}{l^4 12}$
3-inch and 4-inch decking	$\sigma_b = \frac{20F'_b d^2}{3l^2 6}$	$\sigma_\Delta = \frac{116\Delta E' d^3}{l^4 12}$

For SI: 1 inch = 25.4 mm.

- a.  $\sigma_b$  = Allowable total uniform load limited by bending.  
 $\sigma_\Delta$  = Allowable total uniform load limited by deflection.
- b.  $d$  = Actual decking thickness.  
 $l$  = Span of decking.  
 $F'_b$  = Allowable bending stress adjusted by applicable factors.  
 $E'$  = Modulus of elasticity adjusted by applicable factors.

**2306.3 Wood-frame shear walls.** Wood-frame shear walls shall be designed and constructed in accordance with AF&PA SDPWS. Where panels are fastened to framing members with staples, requirements and limitations of AF&PA SDPWS shall be met and the allowable shear values set forth in Table 2306.3(1), 2306.3(2) or 2306.3(3) shall be permitted. The allowable shear values in Tables 2306.3(1) and 2306.3(2) are permitted to be increased 40 percent for wind design. Panels complying with ANSI/APA PRP-210 shall be permitted to use design values for Plywood Siding in the AF&PA SDPWS.

### SECTION 2307 LOAD AND RESISTANCE FACTOR DESIGN

**2307.1 Load and resistance factor design.** The design and construction of wood elements and structures using *load and resistance factor design* shall be in accordance with AF&PA NDS and AF&PA SDPWS.

TABLE 2306.2(1)  
ALLOWABLE SHEAR VALUES (POUNDS PER FOOT) FOR WOOD STRUCTURAL PANEL DIAPHRAGMS UTILIZING STAPLES  
WITH FRAMING OF DOUGLAS FIR-LARCH, OR SOUTHERN PINE<sup>a</sup> FOR WIND OR SEISMIC LOADING<sup>c</sup>

PANEL GRADE	STAPLE LENGTH AND GAGE <sup>d</sup>	MINIMUM FASTENER PENETRATION IN FRAMING (inches)	MINIMUM NOMINAL PANEL THICKNESS (inch)	MINIMUM NOMINAL WIDTH OF FRAMING MEMBERS AT ADJOINING PANEL EDGES AND BOUNDARIES <sup>e</sup> (inches)	BLOCKED DIAPHRAGMS					UNBLOCKED DIAPHRAGMS										
					Fastener spacing (inches) at diaphragm boundaries (all cases) at continuous panel edges parallel to load (Cases 3, 4), and at all panel edges (Cases 5, 6) <sup>b</sup>					Fasteners spaced 6 max. at supported edges <sup>b</sup>		Case 1 (No unblocked edges or continuous joints parallel to load)								
					6	4	2 1/2 <sup>c</sup>	2 <sup>c</sup>	6					4	3					
Structural I grades	1 1/2 16 gage	1	3/8	2	6	4	2 1/2 <sup>c</sup>	2 <sup>c</sup>	6	4	3	6	4	3	175	235	350	400	155	115
					3	200	265	395	450	175	130									
					2	175	235	350	400	155	120									
					3	200	265	395	450	175	130									
					2	160	210	315	360	140	105									
					3	180	235	355	400	160	120									
Sheathing, single floor and other grades covered in DOC PS 1 and PS 2	1 1/2 16 gage	1	7/16	2	6	4	2 1/2 <sup>c</sup>	2 <sup>c</sup>	6	4	3	6	4	3	165	225	335	380	150	110
					3	190	250	375	425	165	125									
					2	160	210	315	360	140	105									
					3	180	235	355	405	160	120									
					2	175	235	350	400	155	115									
					3	200	265	395	450	175	130									

(continued)

TABLE 2306.2(1)—continued  
 ALLOWABLE SHEAR VALUES (POUNDS PER FOOT) FOR WOOD STRUCTURAL PANEL DIAPHRAGMS UTILIZING STAPLES WITH FRAMING OF DOUGLAS FIR-LARCH, OR SOUTHERN PINE<sup>a</sup> FOR WIND OR SEISMIC LOADING<sup>b</sup>

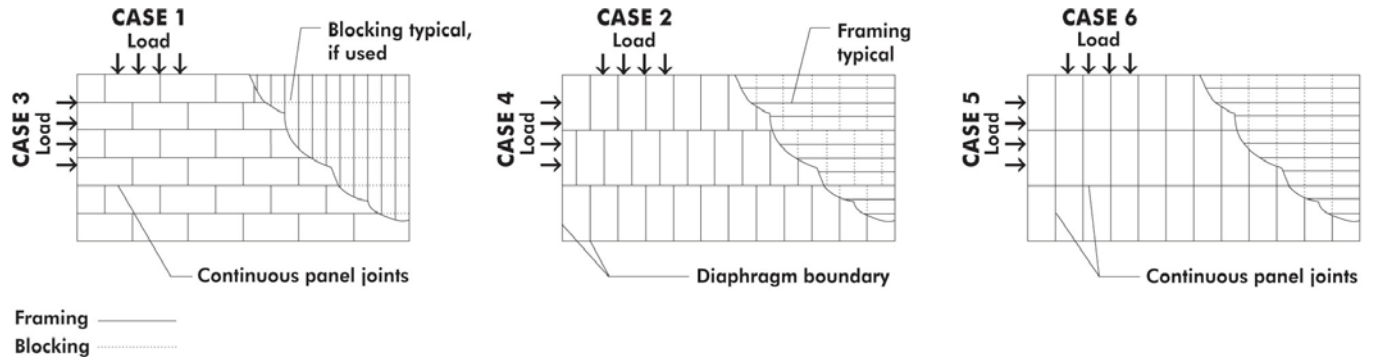

For SI: 1 inch = 25.4 mm, 1 pound per foot = 14.5939 N/m.

- For framing of other species: (1) Find specific gravity for species of lumber in AF&PA NDS. (2) For staples find shear value from table above for Structural I panels (regardless of actual grade) and multiply value by 0.82 for species with specific gravity of 0.42 or greater, or 0.65 for all other species.
- Space fasteners maximum 12 inches o.c. along intermediate framing members (6 inches o.c. where supports are spaced 48 inches o.c.).
- Framing at adjoining panel edges shall be 3 inches nominal or wider.
- Staples shall have a minimum crown width of  $\frac{7}{16}$  inch and shall be installed with their crowns parallel to the long dimension of the framing members.
- The minimum nominal width of framing members not located at boundaries or adjoining panel edges shall be 2 inches.
- For shear loads of normal or permanent load duration as defined by the AF&PA NDS, the values in the table above shall be multiplied by 0.63 or 0.56, respectively.

**TABLE 2306.2(2)**  
**ALLOWABLE SHEAR VALUES (POUNDS PER FOOT) FOR WOOD STRUCTURAL PANEL BLOCKED DIAPHRAGMS**  
**UTILIZING MULTIPLE ROWS OF STAPLES (HIGH-LOAD DIAPHRAGMS) WITH FRAMING OF**  
**DOUGLAS FIR-LARCH OR SOUTHERN PINE<sup>a</sup> FOR WIND OR SEISMIC LOADING<sup>b, g, h</sup>**

PANEL GRADE <sup>c</sup>	STAPLE GAGE <sup>f</sup>	MINIMUM FASTENER PENETRATION IN FRAMING (inches)	MINIMUM NOMINAL PANEL THICKNESS (inch)	MINIMUM NOMINAL WIDTH OF FRAMING MEMBER AT ADJOINING PANEL EDGES AND BOUNDARIES <sup>e</sup>	LINES OF FASTENERS	BLOCKED DIAPHRAGMS					
						Cases 1 and 2 <sup>d</sup>					
						Fastener Spacing Per Line at Boundaries (inches)					
						4		2 <sup>1/2</sup>		2	
						Fastener Spacing Per Line at Other Panel Edges (inches)					
						6	4	4	3	3	2
Structural I grades	14 gage staples	2	15/32	3	2	600	600	860	960	1,060	1,200
				4	3	860	900	1,160	1,295	1,295	1,400
			19/32	3	2	600	600	875	960	1,075	1,200
				4	3	875	900	1,175	1,440	1,475	1,795
Sheathing single floor and other grades covered in DOC PS 1 and PS 2	14 gage staples	2	15/32	3	2	540	540	735	865	915	1,080
				4	3	735	810	1,005	1,105	1,105	1,195
			19/32	3	2	600	600	865	960	1,065	1,200
				4	3	865	900	1,130	1,430	1,370	1,485
			23/32	4	3	865	900	1,130	1,490	1,430	1,545

For SI: 1 inch = 25.4 mm, 1 pound per foot = 14.5939 N/m.

- For framing of other species: (1) Find specific gravity for species of framing lumber in AF&PA NDS. (2) For staples, find shear value from table above for Structural I panels (regardless of actual grade) and multiply value by 0.82 for species with specific gravity of 0.42 or greater, or 0.65 for all other species.
- Fastening along intermediate framing members: Space fasteners a maximum of 12 inches on center, except 6 inches on center for spans greater than 32 inches.
- Panels conforming to PS 1 or PS 2.
- This table gives shear values for Cases 1 and 2 as shown in Table 2306.2(1). The values shown are applicable to Cases 3, 4, 5 and 6 as shown in Table 2306.2(1), providing fasteners at all continuous panel edges are spaced in accordance with the boundary fastener spacing.
- The minimum nominal depth of framing members shall be 3 inches nominal. The minimum nominal width of framing members not located at boundaries or adjoining panel edges shall be 2 inches.
- Staples shall have a minimum crown width of 7/16 inch, and shall be installed with their crowns parallel to the long dimension of the framing members.
- High-load diaphragms shall be subject to special inspection in accordance with Section 1705.5.1.
- For shear loads of normal or permanent load duration as defined by the AF&PA NDS, the values in the table above shall be multiplied by 0.63 or 0.56, respectively.

*(continued)*

**TABLE 2306.2(2)—continued**  
**ALLOWABLE SHEAR VALUES (POUNDS PER FOOT) FOR WOOD STRUCTURAL PANEL BLOCKED DIAPHRAGMS**  
**UTILIZING MULTIPLE ROWS OF STAPLES (HIGH-LOAD DIAPHRAGMS) WITH FRAMING OF**  
**DOUGLAS FIR-LARCH OR SOUTHERN PINE FOR WIND OR SEISMIC LOADING**

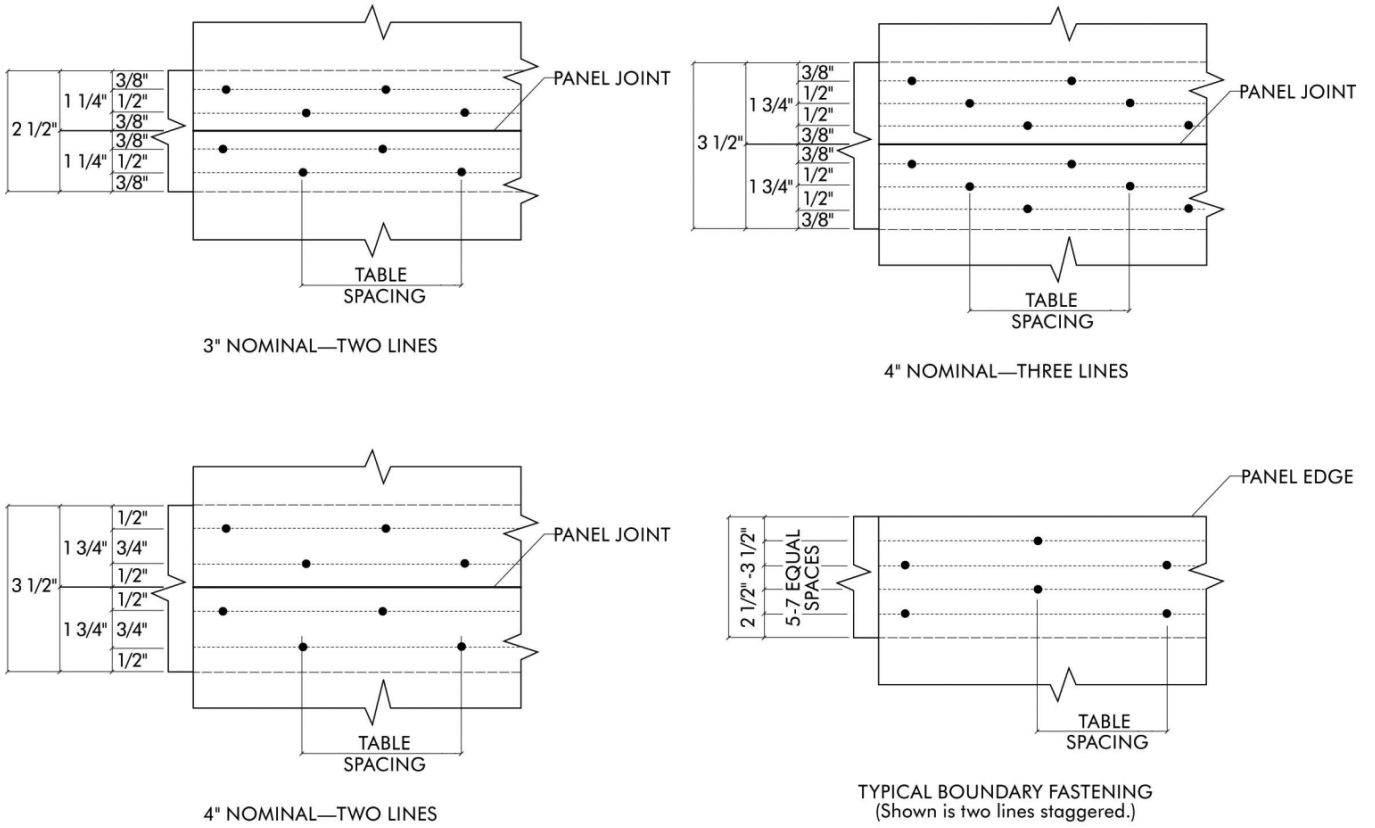

NOTE: SPACE PANEL END AND EDGE JOINT 1/8-INCH. REDUCE SPACING BETWEEN LINES OF NAILS AS NECESSARY TO MAINTAIN MINIMUM 3/8-INCH FASTENER EDGE MARGINS, MINIMUM SPACING BETWEEN LINES IS 3/8-INCH

**TABLE 2306.3(1)**  
**ALLOWABLE SHEAR VALUES (POUNDS PER FOOT) FOR WOOD STRUCTURAL PANEL SHEAR WALLS UTILIZING STAPLES WITH FRAMING OF DOUGLAS FIR-LARCH OR SOUTHERN PINE<sup>a</sup> FOR WIND OR SEISMIC LOADING<sup>b, f, g, i</sup>**

PANEL GRADE	MINIMUM NOMINAL PANEL THICKNESS (inch)	MINIMUM FASTENER PENETRATION IN FRAMING (inches)	PANELS APPLIED DIRECT TO FRAMING				PANELS APPLIED OVER 1/2" OR 5/8" GYPSUM SHEATHING					
			Staple size <sup>h</sup>	Fastener spacing at panel edges (inches)				Staple size <sup>h</sup>	Fastener spacing at panel edges (inches)			
				6	4	3	2 <sup>d</sup>		6	4	3	2 <sup>d</sup>
Structural I sheathing	3/8	1	1 1/2 16 Gage	155	235	315	400	2 16 Gage	155	235	310	400
	7/16			170	260	345	440		155	235	310	400
	15/32			185	280	375	475		155	235	300	400
Sheathing, plywood siding <sup>c</sup> except Group 5 Species, ANSI/APA PRP 210 siding	5/16 <sup>c</sup> or 1/4 <sup>c</sup>	1	1 1/2 16 Gage	145	220	295	375	2 16 Gage	110	165	220	285
	3/8			140	210	280	360		140	210	280	360
	7/16			155	230	310	395		140	210	280	360
	15/32			170	255	335	430		140	210	280	360
	19/32		1 3/4 16 Gage	185	280	375	475	—	—	—	—	—

For SI: 1 inch = 25.4 mm, 1 pound per foot = 14.5939 N/m.

- For framing of other species: (1) Find specific gravity for species of lumber in AF&PA NDS. (2) For staples find shear value from table above for Structural I panels (regardless of actual grade) and multiply value by 0.82 for species with specific gravity of 0.42 or greater, or 0.65 for all other species.
- Panel edges backed with 2-inch nominal or wider framing. Install panels either horizontally or vertically. Space fasteners maximum 6 inches on center along intermediate framing members for 3/8-inch and 7/16-inch panels installed on studs spaced 24 inches on center. For other conditions and panel thickness, space fasteners maximum 12 inches on center on intermediate supports.
- 3/8-inch panel thickness or siding with a span rating of 16 inches on center is the minimum recommended where applied directly to framing as exterior siding. For grooved panel siding, the nominal panel thickness is the thickness of the panel measured at the point of fastening.
- Framing at adjoining panel edges shall be 3 inches nominal or wider.
- Values apply to all-veneer plywood. Thickness at point of fastening on panel edges governs shear values.
- Where panels are applied on both faces of a wall and fastener spacing is less than 6 inches o.c. on either side, panel joints shall be offset to fall on different framing members, or framing shall be 3 inches nominal or thicker at adjoining panel edges.
- In Seismic Design Category D, E or F, where shear design values exceed 350 pounds per linear foot, all framing members receiving edge fastening from abutting panels shall not be less than a single 3-inch nominal member, or two 2-inch nominal members fastened together in accordance with Section 2306.1 to transfer the design shear value between framing members. Wood structural panel joint and sill plate nailing shall be staggered at all panel edges. See AF&PA SDPWS for sill plate size and anchorage requirements.
- Staples shall have a minimum crown width of 7/16 inch and shall be installed with their crowns parallel to the long dimension of the framing members.
- For shear loads of normal or permanent load duration as defined by the AF&PA NDS, the values in the table above shall be multiplied by 0.63 or 0.56, respectively.

**TABLE 2306.3(2)**  
**ALLOWABLE SHEAR VALUES (plf) FOR WIND OR SEISMIC LOADING ON SHEAR WALLS OF FIBERBOARD SHEATHING BOARD CONSTRUCTION UTILIZING STAPLES FOR TYPE V CONSTRUCTION ONLY<sup>a, b, c, d, e</sup>**

THICKNESS AND GRADE	FASTENER SIZE	ALLOWABLE SHEAR VALUE (pounds per linear foot) STAPLE SPACING AT PANEL EDGES (inches) <sup>a</sup>		
		4	3	2
1/2" or 25/32" Structural	No. 11 gage galvanized staple, 7/16" crown <sup>f</sup>	150	200	225
	No. 11 gage galvanized staple, 1" crown <sup>f</sup>	220	290	325

For SI: 1 inch = 25.4 mm, 1 pound per foot = 14.5939 N/m.

- Fiberboard sheathing shall not be used to brace concrete or masonry walls.
- Panel edges shall be backed with 2-inch or wider framing of Douglas fir-larch or Southern pine. For framing of other species: (1) Find specific gravity for species of framing lumber in AF&PA NDS. (2) For staples, multiply the shear value from the table above by 0.82 for species with specific gravity of 0.42 or greater, or 0.65 for all other species.
- Values shown are for fiberboard sheathing on one side only with long panel dimension either parallel or perpendicular to studs.
- Fastener shall be spaced 6 inches on center along intermediate framing members.
- Values are not permitted in Seismic Design Category D, E or F.
- Staple length shall not be less than 1 1/2 inches for 25/32-inch sheathing or 1 1/4 inches for 1/2-inch sheathing.



**TABLE 2306.3(3)**  
**ALLOWABLE SHEAR VALUES FOR WIND OR SEISMIC FORCES FOR SHEAR WALLS OF LATH**  
**AND PLASTER OR GYPSUM BOARD WOOD FRAMED WALL ASSEMBLIES UTILIZING STAPLES**

TYPE OF MATERIAL	THICKNESS OF MATERIAL	WALL CONSTRUCTION	STAPLE SPACING <sup>b</sup> MAXIMUM (inches)	SHEAR VALUE <sup>a,c</sup> (plf)	MINIMUM STAPLE SIZE <sup>f,g</sup>	
1. Expanded metal or woven wire lath and Portland cement plaster	$\frac{7}{8}$ "	Unblocked	6	180	No. 16 gage galv. staple, $\frac{7}{8}$ " legs	
2. Gypsum lath, plain or perforated	$\frac{3}{8}$ " lath and $\frac{1}{2}$ " plaster	Unblocked	5	100	No. 16 gage galv. staple, $1\frac{1}{8}$ " long	
3. Gypsum sheathing	$\frac{1}{2}$ " $\times$ 2' $\times$ 8'	Unblocked	4	75	No. 16 gage galv. staple, $1\frac{3}{4}$ " long	
	$\frac{1}{2}$ " $\times$ 4'	Blocked <sup>d</sup>	4	175		
4. Gypsum board, gypsum veneer base or water-resistant gypsum backing board	$\frac{1}{2}$ "	Unblocked <sup>d</sup>	7	75	No. 16 gage galv. staple, $1\frac{1}{2}$ " long	
		Unblocked <sup>d</sup>	4	110		
		Unblocked	7	100		
		Unblocked	4	125		
		Blocked <sup>e</sup>	7	125		
		Blocked <sup>e</sup>	4	150		
	$\frac{5}{8}$ "	Unblocked <sup>d</sup>		7	115	No. 16 gage galv. staple, $1\frac{1}{2}$ " long No. 15 gage galv. staple, $1\frac{5}{8}$ " long
				4	145	
		Blocked <sup>e</sup>		7	145	
				4	175	
	Blocked <sup>e</sup> Two-ply	Base ply: 9 Face ply: 7	250	No. 16 gage galv. staple $1\frac{5}{8}$ " long No. 15 gage galv. staple, $2\frac{1}{4}$ " long		

For SI: 1 inch = 25.4 mm, 1 foot = 304.8 mm, 1 pound per foot = 14.5939 N/m.

- These shear walls shall not be used to resist loads imposed by masonry or concrete walls (see AF & PA SDPWS). Values shown are for short-term loading due to wind or seismic loading. Walls resisting seismic loads shall be subject to the limitations in Section 12.2.1 of ASCE 7. Values shown shall be reduced 25 percent for normal loading.
- Applies to fastening at studs, top and bottom plates and blocking.
- Except as noted, shear values are based on a maximum framing spacing of 16 inches on center.
- Maximum framing spacing of 24 inches on center.
- All edges are blocked, and edge fastening is provided at all supports and all panel edges.
- Staples shall have a minimum crown width of  $\frac{7}{16}$  inch, measured outside the legs, and shall be installed with their crowns parallel to the long dimension of the framing members.
- Staples for the attachment of gypsum lath and woven-wire lath shall have a minimum crown width of  $\frac{3}{4}$  inch, measured outside the legs.

## SECTION 2308

### CONVENTIONAL LIGHT-FRAME CONSTRUCTION

**2308.1 General.** The requirements of this section are intended for *conventional light-frame construction*. Other construction methods are permitted to be used, provided a satisfactory design is submitted showing compliance with other provisions of this code. Interior non-load-bearing partitions, ceilings and curtain walls of *conventional light-frame construction* are not subject to the limitations of Section 2308.2. Alternatively, compliance with AF&PA WFCM shall be permitted subject to the limitations therein and the limitations of this code. Detached one- and two-family dwellings and multiple single-family dwellings (townhouses) not more than three stories above grade plane in height with a separate means of egress and their accessory structures shall comply with the *Residential Code*.

**2308.1.1 Portions exceeding limitations of conventional light-frame construction.** When portions of a building of otherwise conventional light-frame construction exceed the limits of Section 2308.2, those portions and the sup-

porting load path shall be designed in accordance with accepted engineering practices and the provisions of this code. For the purposes of this section, the term "portions" shall mean parts of buildings containing volume and area such as a room or a series of rooms. The extent of such design need only demonstrate compliance of the nonconventionally light-framed elements with other applicable provisions of this code and shall be compatible with the performance of the conventional light-framed system.

**2308.1.2 Connections and fasteners.** Connectors and fasteners used in conventional construction shall comply with the requirements of Section 2304.9

**2308.2 Limitations.** Buildings are permitted to be constructed in accordance with the provisions of *conventional light-frame construction*, subject to the following limitations;

**2308.2.1 Stories.** Structures of *conventional light-frame construction* shall be limited in story height according to Table 2308.2.1.

**TABLE 2308.2.1  
ALLOWABLE STORY HEIGHT**

SEISMIC DESIGN CATEGORY	ALLOWABLE STORY ABOVE GRADE PLANE
A and B	Three stories
C	Two stories
D and E <sup>a</sup>	One story

a. For the purposes of this section, for buildings assigned to *Seismic Design Category* D or E, cripple walls shall be considered to be a *story* unless cripple walls are solid blocked and do not exceed 14 inches in height,

**2308.2.2 Allowable floor-to-floor height.** Maximum floor-to-floor height shall not exceed 11 feet, 7 inches (3531 mm). Exterior bearing wall and interior braced wall heights shall not exceed a stud height of 10 feet (3048 mm).

**2308.2.3 Allowable loads.** Loads shall be in accordance with Chapter 16 and shall not exceed the following:

1. Average dead loads shall not exceed 15 psf (718 N/m<sup>2</sup>) for combined roof and ceiling, exterior walls, floors and partitions.

**Exceptions:**

1. Subject to the limitations of Section 2308.6.10, stone or masonry veneer up to the lesser of 5 inches (127 mm) thick or 50 psf (2395 N/m<sup>2</sup>) and installed in accordance with Chapter 14 is permitted to a height of 30 feet (9144 mm) above a noncombustible foundation, with an additional 8 feet (2438 mm) permitted for gable ends.
2. Concrete or masonry fireplaces, heaters and chimneys shall be permitted in accordance with the provisions of this code.
3. Live loads shall not exceed 40 psf (1916 N/m<sup>2</sup>) for floors of conventional light-frame construction. Floor live load shall be allowed to exceed 40 psf (1916 N/m<sup>2</sup>) for concrete slab on grade floors.
4. Ground snow loads shall not exceed 50 psf (2395 N/m<sup>2</sup>).

**2308.2.4 Allowable wind speed.**  $V_{asd}$ , as determined in accordance with Section 1609.3.1, shall not exceed 100 miles per hour (mph) (44 m/s) (3-second gust).

**Exceptions:**

1.  $V_{asd}$  as determined in accordance with Section 1609.3.1, shall not exceed 110 mph (48.4 m/s) (3-second gust) for buildings in Exposure Category B that are not located in a *hurricane-prone region*.
2. Where  $V_{asd}$  as determined in accordance with Section 1609.3.1, exceeds 100 mph (44 m/s) (3-second gust), the provisions of either AF&PA WFCM or ICC 600 are permitted to be used. Wind speeds in Figures 1609A, 1609B and 1609C shall be converted in accordance with Section 1609.3.1 for use with AF&PA WFCM or ICC 600.

**2308.2.5 Allowable roof span.** Ceiling joist and rafter framing, constructed in accordance with Section 2308.7, and trusses shall not span more than 40 feet (12 192 mm) between points of vertical support. A ridge board in accordance with Section 2308.7 shall not be considered a vertical support.

**2308.2.6 Risk Category limitation.** The use of the provisions for *conventional light-frame construction* in this section shall not be permitted for *Risk Category* IV buildings, as determined by Section 1604.5, assigned to *Seismic Design Category* B, C, D or E.

**2308.3 Foundations and footings.** Foundations and footings shall be designed and constructed in accordance with Chapter 18. Connections to foundations and footings shall comply with this section.

**2308.3.1 Foundation plates or sills.** Foundation plates or sills resting on concrete or masonry foundations shall comply with Section 2304.3.1. Foundation plates or sills shall be bolted or anchored to the foundation with not less than  $\frac{1}{2}$ -inch-diameter (12.7 mm) steel bolts or *approved* anchors spaced to provide equivalent anchorage as the steel bolts. Bolts shall be embedded at least 7 inches (178 mm) into concrete or masonry.

Bolts shall be spaced not more than 6 feet (1829 mm) apart and there shall be a minimum of two bolts or anchor straps per piece with one bolt or anchor strap located not more than 12 inches (305 mm) or less than 4 inches (102 mm) from each end of each piece. A properly sized nut and washer shall be tightened on each bolt to the plate.

**Exceptions:**

1. Along *braced wall lines* in structures assigned to *Seismic Design Category* E, steel bolts with a minimum nominal diameter of  $\frac{5}{8}$  inch (15.9 mm) or approved anchor straps load rated in accordance with Section 1706.1 and spaced to provide equivalent anchorage shall be used.
2. Bolts in *braced wall lines* in structures over two stories above grade shall be spaced not more the 4 feet (1219 mm) o.c.

**2308.3.2 Braced wall line sill plate anchorage in Seismic Design Category D and E.** Sill plates along *braced wall lines* shall be anchored with anchor bolts with steel plate washers between the foundation sill plate and the nut or *approved* anchor straps load rated in accordance with Section 1706.1. Such washers shall be a minimum of 0.229 inch by 3 inches by 3 inches (5.82 mm by 76 mm by 76 mm) in size. The hole in the plate washer is permitted to be diagonally slotted with a width of up to  $\frac{3}{16}$  inch (4.76 mm) larger than the bolt diameter and a slot length not to exceed  $1\frac{3}{4}$  inches (44 mm), provided a standard cut washer is placed between the plate washer and the nut.

**2308.4 Floor framing.** Floor framing shall comply with this section.

**2308.4.1 Girders.** Girders for single-story construction or girders supporting loads from a single floor shall not be less than 4 inches by 6 inches (102 mm by 152 mm) for spans 6 feet (1829 mm) or less, provided that girders are

spaced not more than 8 feet (2438 mm) on center Spans for built-up 2-inch girders shall be in accordance with Table 2308.4.1(1) or 2308.4.1(2). Other girders shall be designed to support the loads specified in this code. Girder end joints shall occur over supports.

Where a girder is spliced over a support, an adequate tie shall be provided. The ends of beams or girders supported

on masonry or concrete shall not have less than 3 inches (76 mm) of bearing.

**2308.4.2 Floor joists.** Floor joists shall comply with this section.

**2308.4.2.1 Span.** Spans for floor joists shall be in accordance with Tables 2308.4.2(1) or 2308.4.2(2) or the *AF&PA Span Tables for Joists and Rafters*.

**TABLE 2308.4.1(1)**  
**HEADER AND GIRDER SPANS<sup>a</sup> FOR<sup>a</sup> EXTERIOR BEARING WALLS**  
 (Maximum Spans for Douglas Fir-Larch, Hem-Fir, Southern Pine and Spruce-Pine-Fir<sup>b</sup> and Required Number of Jack Studs)

HEADERS SUPPORTING	SIZE	GROUND SNOW LOAD (psf) <sup>e</sup>											
		30						50					
		Building width <sup>c</sup> (feet)											
		20		28		36		20		28		36	
Span	NJ <sup>d</sup>	Span	NJ <sup>d</sup>	Span	NJ <sup>d</sup>	Span	NJ <sup>d</sup>	Span	NJ <sup>d</sup>	Span	NJ <sup>d</sup>	Span	NJ <sup>d</sup>
Roof & Ceiling	2-2x4	3-6	1	3-2	1	2-10	1	3-2	1	2-9	1	2-6	1
	2-2x6	5-5	1	4-8	1	4-2	1	4-8	1	4-1	1	3-8	2
	2-2x8	6-10	1	5-11	2	5-4	2	5-11	2	5-2	2	4-7	2
	2-2x10	8-5	2	7-3	2	6-6	2	7-3	2	6-3	2	5-7	2
	2-2x12	9-9	2	8-5	2	7-6	2	8-5	2	7-3	2	6-6	2
	3-2x8	8-4	1	7-5	1	6-8	1	7-5	1	6-5	2	5-9	2
	3-2x10	10-6	1	9-1	2	8-2	2	9-1	2	7-10	2	7-0	2
	3-2x12	12-2	2	10-7	2	9-5	2	10-7	2	9-2	2	8-2	2
	4-2x8	9-2	1	8-4	1	7-8	1	8-4	1	7-5	1	6-8	1
	4-2x10	11-8	1	10-6	1	9-5	2	10-6	1	9-1	2	8-2	2
4-2x12	14-1	1	12-2	2	10-11	2	12-2	2	10-7	2	9-5	2	
Roof, Ceiling & 1 Center-Bearing Floor	2-2x4	3-1	1	2-9	1	2-5	1	2-9	1	2-5	1	2-2	1
	2-2x6	4-6	1	4-0	1	3-7	2	4-1	1	3-7	2	3-3	2
	2-2x8	5-9	2	5-0	2	4-6	2	5-2	2	4-6	2	4-1	2
	2-2x10	7-0	2	6-2	2	5-6	2	6-4	2	5-6	2	5-0	2
	2-2x12	8-1	2	7-1	2	6-5	2	7-4	2	6-5	2	5-9	3
	3-2x8	7-2	1	6-3	2	5-8	2	6-5	2	5-8	2	5-1	2
	3-2x10	8-9	2	7-8	2	6-11	2	7-11	2	6-11	2	6-3	2
	3-2x12	10-2	2	8-11	2	8-0	2	9-2	2	8-0	2	7-3	2
	4-2x8	8-1	1	7-3	1	6-7	1	7-5	1	6-6	1	5-11	2
	4-2x10	10-1	1	8-10	2	8-0	2	9-1	2	8-0	2	7-2	2
4-2x12	11-9	2	10-3	2	9-3	2	10-7	2	9-3	2	8-4	2	
Roof, Ceiling & 1 Clear Span Floor	2-2x4	2-8	1	2-4	1	2-1	1	2-7	1	2-3	1	2-0	1
	2-2x6	3-11	1	3-5	2	3-0	2	3-10	2	3-4	2	3-0	2
	2-2x8	5-0	2	4-4	2	3-10	2	4-10	2	4-2	2	3-9	2
	2-2x10	6-1	2	5-3	2	4-8	2	5-11	2	5-1	2	4-7	3
	2-2x12	7-1	2	6-1	3	5-5	3	6-10	2	5-11	3	5-4	3
	3-2x8	6-3	2	5-5	2	4-10	2	6-1	2	5-3	2	4-8	2
	3-2x10	7-7	2	6-7	2	5-11	2	7-5	2	6-5	2	5-9	2
	3-2x12	8-10	2	7-8	2	6-10	2	8-7	2	7-5	2	6-8	2
	4-2x8	7-2	1	6-3	2	5-7	2	7-0	1	6-1	2	5-5	2
	4-2x10	8-9	2	7-7	2	6-10	2	8-7	2	7-5	2	6-7	2
4-2x12	10-2	2	8-10	2	7-11	2	9-11	2	8-7	2	7-8	2	

(continued)

**TABLE 2308.4.1(1)—continued**  
**HEADER AND GIRDER SPANS<sup>a</sup> FOR<sup>a</sup> FOR EXTERIOR BEARING WALLS**  
**(Maximum Spans for Douglas Fir-Larch, Hem-Fir, Southern Pine and Spruce-Pine-Fir<sup>b</sup> and Required Number of Jack Studs)**

HEADERS SUPPORTING	SIZE	GROUND SNOW LOAD (psf) <sup>e</sup>											
		30						50					
		Building width <sup>c</sup> (feet)											
		20		28		36		20		28		36	
Span	NJ <sup>d</sup>	Span	NJ <sup>d</sup>	Span	NJ <sup>d</sup>	Span	NJ <sup>d</sup>	Span	NJ <sup>d</sup>	Span	NJ <sup>d</sup>	Span	NJ <sup>d</sup>
Roof, Ceiling & 2 Center-Bearing Floors	2-2×4	2-7	1	2-3	1	2-0	1	2-6	1	2-2	1	1-11	1
	2-2×6	3-9	2	3-3	2	2-11	2	3-8	2	3-2	2	2-10	2
	2-2×8	4-9	2	4-2	2	3-9	2	4-7	2	4-0	2	3-8	2
	2-2×10	5-9	2	5-1	2	4-7	3	5-8	2	4-11	2	4-5	3
	2-2×12	6-8	2	5-10	3	5-3	3	6-6	2	5-9	3	5-2	3
	3-2×8	5-11	2	5-2	2	4-8	2	5-9	2	5-1	2	4-7	2
	3-2×10	7-3	2	6-4	2	5-8	2	7-1	2	6-2	2	5-7	2
	3-2×12	8-5	2	7-4	2	6-7	2	8-2	2	7-2	2	6-5	3
	4-2×8	6-10	1	6-0	2	5-5	2	6-8	1	5-10	2	5-3	2
	4-2×10	8-4	2	7-4	2	6-7	2	8-2	2	7-2	2	6-5	2
4-2×12	9-8	2	8-6	2	7-8	2	9-5	2	8-3	2	7-5	2	
Roof, Ceiling & 2 Clear Span Floors	2-2×4	2-1	1	1-8	1	1-6	2	2-0	1	1-8	1	1-5	2
	2-2×6	3-1	2	2-8	2	2-4	2	3-0	2	2-7	2	2-3	2
	2-2×8	3-10	2	3-4	2	3-0	3	3-10	2	3-4	2	2-11	3
	2-2×10	4-9	2	4-1	3	3-8	3	4-8	2	4-0	3	3-7	3
	2-2×12	5-6	3	4-9	3	4-3	3	5-5	3	4-8	3	4-2	3
	3-2×8	4-10	2	4-2	2	3-9	2	4-9	2	4-1	2	3-8	2
	3-2×10	5-11	2	5-1	2	4-7	3	5-10	2	5-0	2	4-6	3
	3-2×12	6-10	2	5-11	3	5-4	3	6-9	2	5-10	3	5-3	3
	4-2×8	5-7	2	4-10	2	4-4	2	5-6	2	4-9	2	4-3	2
	4-2×10	6-10	2	5-11	2	5-3	2	6-9	2	5-10	2	5-2	2
4-2×12	7-11	2	6-10	2	6-2	3	7-9	2	6-9	2	6-0	3	

For SI: 1 inch = 25.4 mm, 1 foot = 304.8 mm, 1 pound per square foot = 47.8 N/m<sup>2</sup>.

- Spans are given in feet and inches (ft-in).
- Tabulated values are for No. 2 grade lumber.
- Building width is measured perpendicular to the ridge. For widths between those shown, spans are permitted to be interpolated.
- NJ - Number of jack studs required to support each end. Where the number of required jack studs equals one, the header is permitted to be supported by an approved framing anchor attached to the full-height wall stud and to the header.
- Use 30 pounds per square foot ground snow load for cases in which ground snow load is less than 30 pounds per square foot and the roof live load is equal to or less than 20 pounds per square foot.

**TABLE 2308.4.1(2)**  
**HEADER AND GIRDER SPANS<sup>a</sup> FOR INTERIOR BEARING WALLS**  
**(Maximum Spans for Douglas Fir-Larch, Hem-Fir, Southern Pine and Spruce-Pine-Fir<sup>b</sup> and Required Number of Jack Studs)**

HEADERS AND GIRDERS SUPPORTING	SIZE	BUILDING width <sup>c</sup> (feet)					
		20		28		36	
		Span	NJ <sup>d</sup>	Span	NJ <sup>d</sup>	Span	NJ <sup>d</sup>
One Floor Only	2-2x4	3-1	1	2-8	1	2-5	1
	2-2x6	4-6	1	3-11	1	3-6	1
	2-2x8	5-9	1	5-0	2	4-5	2
	2-2x10	7-0	2	6-1	2	5-5	2
	2-2x12	8-1	2	7-0	2	6-3	2
	3-2x8	7-2	1	6-3	1	5-7	2
	3-2x10	8-9	1	7-7	2	6-9	2
	3-2x12	10-2	2	8-10	2	7-10	2
	4-2x8	9-0	1	7-8	1	6-9	1
	4-2x10	10-1	1	8-9	1	7-10	2
Two Floors	2-2x4	2-2	1	1-10	1	1-7	1
	2-2x6	3-2	2	2-9	2	2-5	2
	2-2x8	4-1	2	3-6	2	3-2	2
	2-2x10	4-11	2	4-3	2	3-10	3
	2-2x12	5-9	2	5-0	3	4-5	3
	3-2x8	5-1	2	4-5	2	3-11	2
	3-2x10	6-2	2	5-4	2	4-10	2
	3-2x12	7-2	2	6-3	2	5-7	3
	4-2x8	6-1	1	5-3	2	4-8	2
	4-2x10	7-2	2	6-2	2	5-6	2
4-2x12	8-4	2	7-2	2	6-5	2	

For SI: 1 inch = 25.4 mm, 1 foot = 304.8 mm.

a. Spans are given in feet and inches (ft-in).

b. Tabulated values are for No. 2 grade lumber.

c. Building width is measured perpendicular to the ridge. For widths between those shown, spans are permitted to be interpolated.

d. NJ - Number of jack studs required to support each end. Where the number of required jack studs equals one, the headers are permitted to be supported by an approved framing anchor attached to the full-height wall stud and to the header.

**TABLE 2308.4.2(1)**  
**FLOOR JOIST SPANS FOR COMMON LUMBER SPECIES**  
 (Residential Sleeping Areas, Live Load = 30 psf, L/Δ = 360)

JOIST SPACING (inches)	SPECIES AND GRADE		DEAD LOAD = 10 psf				DEAD LOAD = 20 psf			
			2x6	2x8	2x10	2x12	2x6	2x8	2x10	2x12
			Maximum floor joist spans							
			(ft. - in.)	(ft. - in.)	(ft. - in.)	(ft. - in.)	(ft. - in.)	(ft. - in.)	(ft. - in.)	(ft. - in.)
12	Douglas Fir-Larch	SS	12-6	16-6	21-0	25-7	12-6	16-6	21-0	25-7
	Douglas Fir-Larch	#1	12-0	15-10	20-3	24-8	12-0	15-7	19-0	22-0
	Douglas Fir-Larch	#2	11-10	15-7	19-10	23-0	11-6	14-7	17-9	20-7
	Douglas Fir-Larch	#3	9-8	12-4	15-0	17-5	8-8	11-0	13-5	15-7
	Hem-Fir	SS	11-10	15-7	19-10	24-2	11-10	15-7	19-10	24-2
	Hem-Fir	#1	11-7	15-3	19-5	23-7	11-7	15-2	18-6	21-6
	Hem-Fir	#2	11-0	14-6	18-6	22-6	11-0	14-4	17-6	20-4
	Hem-Fir	#3	9-8	12-4	15-0	17-5	8-8	11-0	13-5	15-7
	Southern Pine	SS	12-3	16-2	20-8	25-1	12-3	16-2	20-8	25-1
	Southern Pine	#1	12-0	15-10	20-3	24-8	12-0	15-10	20-3	24-8
	Southern Pine	#2	11-10	15-7	19-10	24-2	11-10	15-7	18-7	21-9
	Southern Pine	#3	10-5	13-3	15-8	18-8	9-4	11-11	14-0	16-8
	Spruce-Pine-Fir	SS	11-7	15-3	19-5	23-7	11-7	15-3	19-5	23-7
	Spruce-Pine-Fir	#1	11-3	14-11	19-0	23-0	11-3	14-7	17-9	20-7
	Spruce-Pine-Fir	#2	11-3	14-11	19-0	23-0	11-3	14-7	17-9	20-7
	Spruce-Pine-Fir	#3	9-8	12-4	15-0	17-5	8-8	11-0	13-5	15-7
16	Douglas Fir-Larch	SS	11-4	15-0	19-1	23-3	11-4	15-0	19-1	23-0
	Douglas Fir-Larch	#1	10-11	14-5	18-5	21-4	10-8	13-6	16-5	19-1
	Douglas Fir-Larch	#2	10-9	14-1	17-2	19-11	9-11	12-7	15-5	17-10
	Douglas Fir-Larch	#3	8-5	10-8	13-0	15-1	7-6	9-6	11-8	13-6
	Hem-Fir	SS	10-9	14-2	18-0	21-11	10-9	14-2	18-0	21-11
	Hem-Fir	#1	10-6	13-10	17-8	20-9	10-4	13-1	16-0	18-7
	Hem-Fir	#2	10-0	13-2	16-10	19-8	9-10	12-5	15-2	17-7
	Hem-Fir	#3	8-5	10-8	13-0	15-1	7-6	9-6	11-8	13-6
	Southern Pine	SS	11-2	14-8	18-9	22-10	11-2	14-8	18-9	22-10
	Southern Pine	#1	10-11	14-5	18-5	22-5	10-11	14-5	17-11	21-4
	Southern Pine	#2	10-9	14-2	18-0	21-1	10-5	13-6	16-1	18-10
	Southern Pine	#3	9-0	11-6	13-7	16-2	8-1	10-3	12-2	14-6
	Spruce-Pine-Fir	SS	10-6	13-10	17-8	21-6	10-6	13-10	17-8	21-4
	Spruce-Pine-Fir	#1	10-3	13-6	17-2	19-11	9-11	12-7	15-5	17-10
	Spruce-Pine-Fir	#2	10-3	13-6	17-2	19-11	9-11	12-7	15-5	17-10
	Spruce-Pine-Fir	#3	8-5	10-8	13-0	15-1	7-6	9-6	11-8	13-6
19.2	Douglas Fir-Larch	SS	10-8	14-1	18-0	21-10	10-8	14-1	18-0	21-0
	Douglas Fir-Larch	#1	10-4	13-7	16-9	19-6	9-8	12-4	15-0	17-5
	Douglas Fir-Larch	#2	10-1	12-10	15-8	18-3	9-1	11-6	14-1	16-3
	Douglas Fir-Larch	#3	7-8	9-9	11-10	13-9	6-10	8-8	10-7	12-4
	Hem-Fir	SS	10-1	13-4	17-0	20-8	10-1	13-4	17-0	20-7
	Hem-Fir	#1	9-10	13-0	16-4	19-0	9-6	12-0	14-8	17-0
	Hem-Fir	#2	9-5	12-5	15-6	17-1	8-11	11-4	13-10	16-1
	Hem-Fir	#3	7-8	9-9	11-10	13-9	6-10	8-8	10-7	12-4

(continued)

**TABLE 2308.4.2(1)—continued**  
**FLOOR JOIST SPANS FOR COMMON LUMBER SPECIES**  
**(Residential Sleeping Areas, Live Load = 30 psf, L/Δ = 360)**

JOIST SPACING (inches)	SPECIES AND GRADE		DEAD LOAD = 10 psf				DEAD LOAD = 20 psf			
			2x6	2x8	2x10	2x12	2x6	2x8	2x10	2x12
			Maximum floor joist spans							
			(ft. - in.)	(ft. - in.)	(ft. - in.)	(ft. - in.)	(ft. - in.)	(ft. - in.)	(ft. - in.)	(ft. - in.)
19.2	Southern Pine	SS	10-6	13-10	17-8	21-6	10-6	13-10	17-8	21-6
	Southern Pine	#1	10-4	13-7	17-4	21-1	10-4	13-7	16-4	19-6
	Southern Pine	#2	10-1	13-4	16-5	19-3	9-6	12-4	14-8	17-2
	Southern Pine	#3	8-3	10-6	12-5	14-9	7-4	9-5	11-1	13-2
	Spruce-Pine-Fir	SS	9-10	13-0	16-7	20-2	9-10	13-0	16-7	19-6
	Spruce-Pine-Fir	#1	9-8	12-9	15-8	18-3	9-1	11-6	14-1	16-3
	Spruce-Pine-Fir	#2	9-8	12-9	15-8	18-3	9-1	11-6	14-1	16-3
	Spruce-Pine-Fir	#3	7-8	9-9	11-10	13-9	6-10	8-8	10-7	12-4
24	Douglas Fir-Larch	SS	9-11	13-1	16-8	20-3	9-11	13-1	16-2	18-9
	Douglas Fir-Larch	#1	9-7	12-4	15-0	17-5	8-8	11-0	13-5	15-7
	Douglas Fir-Larch	#2	9-1	11-6	14-1	16-3	8-1	10-3	12-7	14-7
	Douglas Fir-Larch	#3	6-10	8-8	10-7	12-4	6-2	7-9	9-6	11-0
	Hem-Fir	SS	9-4	12-4	15-9	19-2	9-4	12-4	15-9	18-5
	Hem-Fir	#1	9-2	12-0	14-8	17-0	8-6	10-9	13-1	15-2
	Hem-Fir	#2	8-9	11-4	13-10	16-1	8-0	10-2	12-5	14-4
	Hem-Fir	#3	6-10	8-8	10-7	12-4	6-2	7-9	9-6	11-0
	Southern Pine	SS	9-9	12-10	16-5	19-11	9-9	12-10	16-5	19-11
	Southern Pine	#1	9-7	12-7	16-1	19-6	9-7	12-4	14-7	17-5
	Southern Pine	#2	9-4	12-4	14-8	17-2	8-6	11-0	13-1	15-5
	Southern Pine	#3	7-4	9-5	11-1	13-2	6-7	8-5	9-11	11-10
	Spruce-Pine-Fir	SS	9-2	12-1	15-5	18-9	9-2	12-1	15-0	17-5
	Spruce-Pine-Fir	#1	8-11	11-6	14-1	16-3	8-1	10-3	12-7	14-7
	Spruce-Pine-Fir	#2	8-11	11-6	14-1	16-3	8-1	10-3	12-7	14-7
	Spruce-Pine-Fir	#3	6-10	8-8	10-7	12-4	6-2	7-9	9-6	11-0

For SI: 1 inch = 25.4 mm, 1 foot = 304.8 mm, 1 pound per square foot = 47.8 N/m<sup>2</sup>.

**TABLE 2308.4.2(2)**  
**FLOOR JOIST SPANS FOR COMMON LUMBER SPECIES**  
**(Residential Living Areas, Live Load = 40 psf, L/Δ = 360)**

JOIST SPACING (inches)	SPECIES AND GRADE		DEAD LOAD = 10 psf				DEAD LOAD = 20 psf			
			2x6	2x8	2x10	2x12	2x6	2x8	2x10	2x12
			Maximum floor joist spans							
			(ft. - in.)	(ft. - in.)	(ft. - in.)	(ft. - in.)	(ft. - in.)	(ft. - in.)	(ft. - in.)	(ft. - in.)
12	Douglas Fir-Larch	SS	11-4	15-0	19-1	23-3	11-4	15-0	19-1	23-3
	Douglas Fir-Larch	#1	10-11	14-5	18-5	22-0	10-11	14-2	17-4	20-1
	Douglas Fir-Larch	#2	10-9	14-2	17-9	20-7	10-6	13-3	16-3	18-10
	Douglas Fir-Larch	#3	8-8	11-0	13-5	15-7	7-11	10-0	12-3	14-3
	Hem-Fir	SS	10-9	14-2	18-0	21-11	10-9	14-2	18-0	21-11
	Hem-Fir	#1	10-6	13-10	17-8	21-6	10-6	13-10	16-11	19-7
	Hem-Fir	#2	10-0	13-2	16-10	20-4	10-0	13-1	16-0	18-6
	Hem-Fir	#3	8-8	11-0	13-5	15-7	7-11	10-0	12-3	14-3
	Southern Pine	SS	11-2	14-8	18-9	22-10	11-2	14-8	18-9	22-10
	Southern Pine	#1	10-11	14-5	18-5	22-5	10-11	14-5	18-5	22-5
	Southern Pine	#2	10-9	14-2	18-0	21-9	10-9	14-2	16-11	19-10
	Southern Pine	#3	9-4	11-11	14-0	16-8	8-6	10-10	12-10	15-3
	Spruce-Pine-Fir	SS	10-6	13-10	17-8	21-6	10-6	13-10	17-8	21-6
	Spruce-Pine-Fir	#1	10-3	13-6	17-3	20-7	10-3	13-3	16-3	18-10
	Spruce-Pine-Fir	#2	10-3	13-6	17-3	20-7	10-3	13-3	16-3	18-10
	Spruce-Pine-Fir	#3	8-8	11-0	13-5	15-7	7-11	10-0	12-3	14-3
16	Douglas Fir-Larch	SS	10-4	13-7	17-4	21-1	10-4	13-7	17-4	21-0
	Douglas Fir-Larch	#1	9-11	13-1	16-5	19-1	9-8	12-4	15-0	17-5
	Douglas Fir-Larch	#2	9-9	12-7	15-5	17-10	9-1	11-6	14-1	16-3
	Douglas Fir-Larch	#3	7-6	9-6	11-8	13-6	6-10	8-8	10-7	12-4
	Hem-Fir	SS	9-9	12-10	16-5	19-11	9-9	12-10	16-5	19-11
	Hem-Fir	#1	9-6	12-7	16-0	18-7	9-6	12-0	14-8	17-0
	Hem-Fir	#2	9-1	12-0	15-2	17-7	8-11	11-4	13-10	16-1
	Hem-Fir	#3	7-6	9-6	11-8	13-6	6-10	8-8	10-7	12-4
	Southern Pine	SS	10-2	13-4	17-0	20-9	10-2	13-4	17-0	20-9
	Southern Pine	#1	9-11	13-1	16-9	20-4	9-11	13-1	16-4	19-6
	Southern Pine	#2	9-9	12-10	16-1	18-10	9-6	12-4	14-8	17-2
	Southern Pine	#3	8-1	10-3	12-2	14-6	7-4	9-5	11-1	13-2
	Spruce-Pine-Fir	SS	9-6	12-7	16-0	19-6	9-6	12-7	16-0	19-6
	Spruce-Pine-Fir	#1	9-4	12-3	15-5	17-10	9-1	11-6	14-1	16-3
	Spruce-Pine-Fir	#2	9-4	12-3	15-5	17-10	9-1	11-6	14-1	16-3
	Spruce-Pine-Fir	#3	7-6	9-6	11-8	13-6	6-10	8-8	10-7	12-4
19.2	Douglas Fir-Larch	SS	9-8	12-10	16-4	19-10	9-8	12-10	16-4	19-2
	Douglas Fir-Larch	#1	9-4	12-4	15-0	17-5	8-10	11-3	13-8	15-11
	Douglas Fir-Larch	#2	9-1	11-6	14-1	16-3	8-3	10-6	12-10	14-10
	Douglas Fir-Larch	#3	6-10	8-8	10-7	12-4	6-3	7-11	9-8	11-3
	Hem-Fir	SS	9-2	12-1	15-5	18-9	9-2	12-1	15-5	18-9
	Hem-Fir	#1	9-0	11-10	14-8	17-0	8-8	10-11	13-4	15-6
	Hem-Fir	#2	8-7	11-3	13-10	16-1	8-2	10-4	12-8	14-8
	Hem-Fir	#3	6-10	8-8	10-7	12-4	6-3	7-11	9-8	11-3
	Southern Pine	SS	9-6	12-7	16-0	19-6	9-6	12-7	16-0	19-6
	Southern Pine	#1	9-4	12-4	15-9	19-2	9-4	12-4	14-11	17-9
	Southern Pine	#2	9-2	12 -1	14-8	17-2	8-8	11-3	13-5	15-8
	Southern Pine	#3	7-4	9-5	11-1	13-2	6-9	8-7	10-1	12-1
	Spruce-Pine-Fir	SS	9-0	11-10	15-1	18-4	9-0	11-10	15-1	17-9
	Spruce-Pine-Fir	#1	8-9	11-6	14-1	16-3	8-3	10-6	12-10	14-10
	Spruce-Pine-Fir	#2	8-9	11-6	14-1	16-3	8-3	10-6	12-10	14-10
	Spruce-Pine-Fir	#3	6-10	8-8	10-7	12-4	6-3	7-11	9-8	11-3

(continued)



TABLE 2308.4.2(2)—continued  
**FLOOR JOIST SPANS FOR COMMON LUMBER SPECIES**  
 (Residential Living Areas, Live Load = 40 psf, L/Δ = 360)

JOIST SPACING (inches)	SPECIES AND GRADE		DEAD LOAD = 10 psf				DEAD LOAD = 20 psf			
			2x6	2x8	2x10	2x12	2x6	2x8	2x10	2x12
			Maximum floor joist spans							
		(ft. - in.)	(ft. - in.)	(ft. - in.)	(ft. - in.)	(ft. - in.)	(ft. - in.)	(ft. - in.)	(ft. - in.)	
24	Douglas Fir-Larch	SS	9-0	11-11	15-2	18-5	9-0	11-11	14-9	17-1
	Douglas Fir-Larch	#1	8-8	11-0	13-5	15-7	7-11	10-0	12-3	14-3
	Douglas Fir-Larch	#2	8-1	10-3	12-7	14-7	7-5	9-5	11-6	13-4
	Douglas Fir-Larch	#3	6-2	7-9	9-6	11-0	5-7	7-1	8-8	10-1
	Hem-Fir	SS	8-6	11-3	14-4	17-5	8-6	11-3	14-4	16-10 <sup>a</sup>
	Hem-Fir	#1	8-4	10-9	13-1	15-2	7-9	9-9	11-11	13-10
	Hem-Fir	#2	7-11	10-2	12-5	14-4	7-4	9-3	11-4	13-1
	Hem-Fir	#3	6-2	7-9	9-6	11-0	5-7	7-1	8-8	10-1
	Southern Pine	SS	8-10	11-8	14-11	18-1	8-10	11-8	14-11	18-1
	Southern Pine	#1	8-8	11-5	14-7	17-5	8-8	11-3	13-4	15-11
	Southern Pine	#2	8-6	11-0	13-1	15-5	7-9	10-0	12-0	14-0
	Southern Pine	#3	6-7	8-5	9-11	11-10	6-0	7-8	9-1	10-9
	Spruce-Pine-Fir	SS	8-4	11-0	14-0	17-0	8-4	11-0	13-8	15-11
	Spruce-Pine-Fir	#1	8-1	10-3	12-7	14-7	7-5	9-5	11-6	13-4
	Spruce-Pine-Fir	#2	8-1	10-3	12-7	14-7	7-5	9-5	11-6	13-4
	Spruce-Pine-Fir	#3	6-2	7-9	9-6	11-0	5-7	7-1	8-8	10-1

For SI: 1 inch = 25.4 mm, 1 foot = 304.8 mm, 1 pound per square foot = 47.8 N/m<sup>2</sup>.

a. End bearing length shall be increased to 2 inches.

**2308.4.2.2 Bearing.** The ends of each joist shall not have less than 1½ inches (38 mm) of bearing on wood or metal, or not less than 3 inches (76 mm) on masonry, except where supported on a 1-inch by 4-inch (25.4 mm by 102 mm) ribbon strip and nailed to the adjoining stud.

**2308.4.2.3 Framing details.** Joists shall be supported laterally at the ends and at each support by solid blocking except where the ends of the joists are nailed to a header, band or rim joist or to an adjoining stud or by other means. Solid blocking shall not be less than 2 inches (51 mm) in thickness and the full depth of the joist. Joist framing from opposite sides of a beam, girder or partition shall be lapped at least 3 inches (76 mm) or the opposing joists shall be tied together in an approved manner. Joists framing into the side of a wood girder shall be supported by framing anchors or on ledger strips not less than 2 inches by 2 inches (51 mm by 51 mm).

**2308.4.2.4 Notches and holes.** Notches on the ends of joists shall not exceed one-fourth the joist depth. Notches in the top or bottom of joists shall not exceed one sixth the depth and shall not be located in the middle third of the span. Holes bored in joists shall not be within 2 inches (51 mm) of the top or bottom of the joist and the diameter of any such hole shall not exceed one-third the depth of the joist.

**2308.4.3 Engineered wood products.** Engineered wood products shall be installed in accordance with manufacturer's recommendations. Cuts, notches and holes bored in trusses, structural composite lumber, structural glue-lami-

nated members or I-joists are not permitted except where permitted by the manufacturer's recommendations or where the effects of such alterations are specifically considered in the design of the member by a *registered design professional*.

**2308.4.4 Framing around openings.** Trimmer and header joists shall be doubled, or of lumber of equivalent cross section, where the span of the header exceeds 4 feet (1219 mm). The ends of header joists more than 6 feet (1829 mm) long shall be supported by framing anchors or joist hangers unless bearing on a beam, partition or wall. Tail joists over 12 feet (3658 mm) long shall be supported at the header by framing anchors or on ledger strips not less than 2 inches by 2 inches (51 mm by 51 mm).

**2308.4.4.1 Openings in floor diaphragms in Seismic Design Categories B, C, D and E.** Openings in floor diaphragms in *Seismic Design Categories B, C, D and E* with a dimension greater than 4 feet (1219 mm) shall be constructed with metal ties and blocking in accordance with this section and Figure 2308.4.4.1(1). Metal ties shall not be less than 0.058 inch [1.47 mm (16 galvanized gauge)] thick by 1½ inches (38 mm) wide with a minimum yield stress of 33,000 psi (227 Mpa). Blocking shall extend not less than the dimension of the opening in the direction of the tie and blocking. Ties shall be attached to blocking in accordance with the manufacturer's instructions but with not less than eight 16d common nails on each side of the header-joist intersection.

Openings in floor diaphragms in *Seismic Design Categories D and E* shall not have any dimension

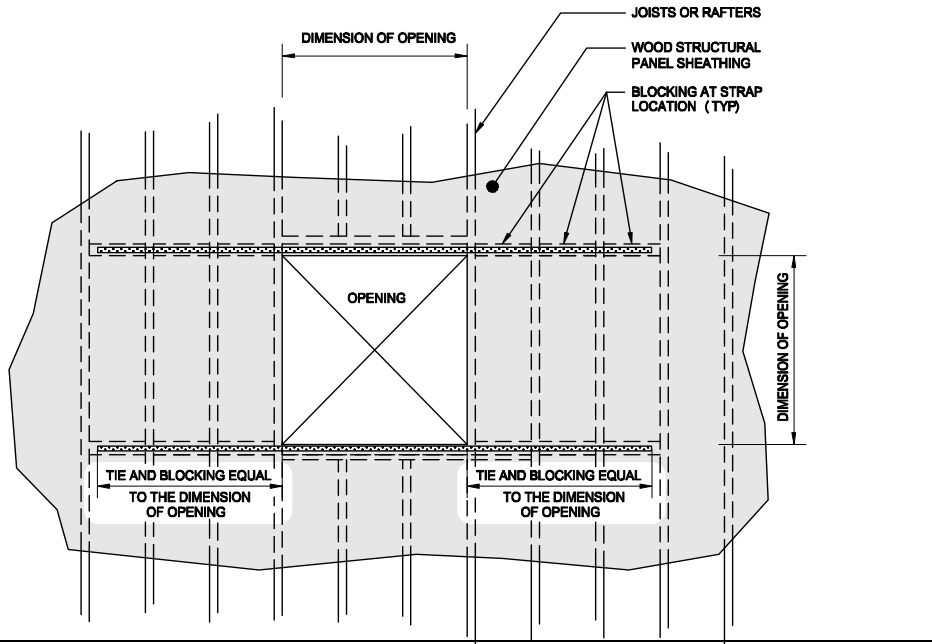

For SI: 1 foot = 304.8 mm.

**FIGURE 2308.4.4.1(1)**  
**OPENINGS IN FLOOR AND ROOF DIAPHRAGMS**

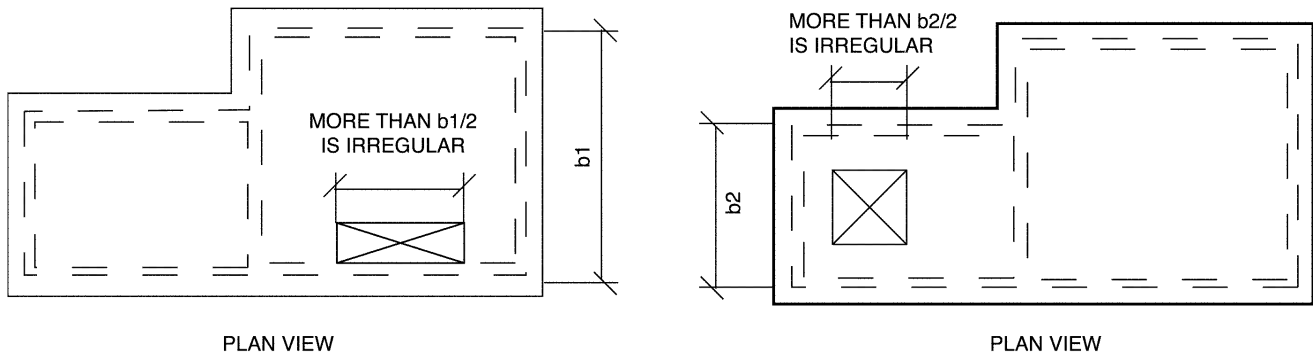

**FIGURE 2308.4.4.1(2)**  
**OPENING LIMITATIONS FOR FLOOR AND ROOF DIAPHRAGMS**

exceeding 50 percent of the distance between braced wall lines or an area greater than 25 percent of the area between orthogonal pairs of braced wall lines [see Figure 2308.4.4.1(2)], or the portion of the structure containing the opening shall be designed in accordance with accepted engineering practice to resist the forces specified in Chapter 16, to the extent such irregular opening affects the performance of the conventional framing system.

**2308.4.4.2 Vertical offsets in floor diaphragms in Seismic Design Categories D and E.** In *Seismic Design Categories D and E*, portions of a floor level shall not be vertically offset such that the framing members on either side of the offset cannot be lapped

or tied together in an *approved* manner in accordance with Figure 2308.4.4.2 unless the portion of the structure containing the irregular offset is designed in accordance with accepted engineering practice.

**Exception:** Framing supported directly by foundations need not be lapped or tied directly together.

**2308.4.5 Joists supporting bearing partitions.** Bearing partitions parallel to joists shall be supported on beams, girders, doubled joists, walls or other bearing partitions. Bearing partitions perpendicular to joists shall not be offset from supporting girders, walls or partitions more than the joist depth unless such joists are of sufficient size to carry the additional load.

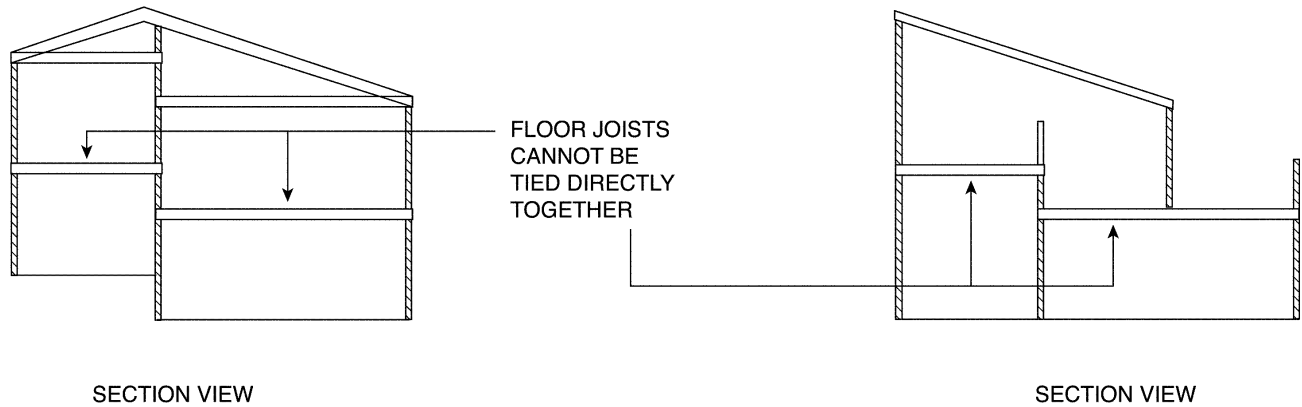

FIGURE 2308.4.4.2  
PORTIONS OF FLOOR LEVEL OFFSET VERTICALLY

**2308.4.6 Lateral support.** Floor and ceiling framing with a nominal depth-to-thickness ratio greater than or equal to 5:1 shall have one edge held in line for the entire span. Where the nominal depth-to-thickness ratio of the framing member exceeds 6:1, there shall be one line of bridging for each 8 feet (2438 mm) of span, unless both edges of the member are held in line. The bridging shall consist of not less than 1-inch by 3-inch (25 mm by 76 mm) lumber, double nailed at each end, of equivalent metal bracing of equal rigidity, full-depth solid blocking or other *approved* means. A line of bridging shall also be required at supports where equivalent lateral support is not otherwise provided.

**2308.4.7 Structural floor sheathing.** Structural floor sheathing shall comply with the provisions of Section 2304.7.1.

**2308.4.8 Under-floor ventilation.** For under-floor ventilation, see Section 1203.3.

**2308.4.9 Floor framing supporting braced wall panels.** When *braced wall panels* are supported by cantilevered floors or are setback from the floor joist support the floor framing shall comply with Section 2308.6.8.

**2308.4.10 Anchorage of exterior means of egress components in Seismic Design Category D and E.** Exterior egress balconies, exterior exit stairways and similar *means of egress* components in structures assigned to *Seismic Design Category D or E* shall be positively anchored to the primary structure at not over 8 feet (2438 mm) o.c. or shall be designed for lateral forces. Such attachment shall not be accomplished by use of toenails or nails subject to withdrawal.

**2308.5 Wall construction.** Walls of *conventional light-frame construction* shall be in accordance with this section.

**2308.5.1 Stud size, height and spacing.** The size, height and spacing of studs shall be in accordance with Table 2308.5.1. Studs shall be continuous from a support at the sole plate to a support at the top plate to resist loads perpendicular to the wall. The support shall be a foundation

or floor, ceiling or roof diaphragm or shall be designed in accordance with accepted engineering practice.

**Exception:** Jack studs, trimmer studs and cripple studs at openings in walls that comply with Table 2308.4.1(1) or 2308.4.1(2).

**2308.5.2 Framing details.** Studs shall be placed with their wide dimension perpendicular to the wall. Not less than three studs shall be installed at each corner of an *exterior wall*.

**Exceptions:**

1. In interior nonbearing walls and partition, studs are permitted to be set with the long dimension parallel to the wall.
2. At corners, two studs are permitted, provided wood spacers or backup cleats of  $\frac{3}{8}$ -inch-thick (9.5 mm) wood structural panel,  $\frac{3}{8}$ -inch (9.5 mm) Type M "Exterior Glue" particleboard, 1-inch-thick (25 mm) lumber or other *approved* devices that will serve as an adequate backing for the attachment of facing materials are used. Where fire-resistance ratings or shear values are involved, wood spacers, backup cleats or other devices shall not be used unless specifically *approved* for such use.

**2308.5.3 Plates and sills.** Studs shall have plates and sills according to this section.

**2308.5.3.1 Bottom plate or sill.** Studs shall have full bearing on a plate or sill. Plates or sills shall not be less than 2 inches (51 mm) nominal in thickness and have a width at least equal to the width of the wall studs.

**2308.5.3.2 Top plates.** Bearing and *exterior wall* studs shall be capped with double top plates installed to provide overlapping at corners and at intersections with other partitions. End joints in double top plates shall be offset at least 48 inches (1219 mm), and shall be nailed with not less than eight 16d face nails on each side of the joint. Plates shall be a nominal 2 inches (51 mm) in

TABLE 2308.5.1  
SIZE, HEIGHT AND SPACING OF WOOD STUDS<sup>c</sup>

STUD SIZE (inches)	BEARING WALLS				NONBEARING WALLS	
	Laterally unsupported stud height <sup>a</sup> (feet)	Supporting roof and ceiling only	Supporting one floor, roof and ceiling	Supporting two floors, roof and ceiling	Laterally unsupported stud height <sup>a</sup> (feet)	Spacing (inches)
2 × 3 <sup>b</sup>	NP	NP	NP	NP	10	16
2 × 4	10	24	16	NP	14	24
3 × 4	10	24	24	16	14	24
2 × 5	10	24	24	NP	16	24
2 × 6	10	24	24	16	20	24

For SI: 1 inch = 25.4 mm, 1 foot = 304.8 mm.

NP = Not Permitted.

- a. Listed heights are distances between points of lateral support placed perpendicular to the plane of the wall. Increases in unsupported height are permitted where justified by an analysis.
- b. Shall not be used in exterior walls.
- c. Utility-grade studs shall not be spaced more than 16 inches (406 mm) o.c., or support more than a roof and ceiling, or exceed 8 feet (2438 mm) in height for exterior walls and load-bearing walls or 10 feet (3048 mm) for interior non-load-bearing walls.

depth and have a width at least equal to the width of the studs.

**Exception:** A single top plate is permitted, provided the plate is adequately tied at joints, corners and intersecting walls by at least the equivalent of 3-inch by 6-inch (76 mm by 152 mm) by 0.036-inch-thick (0.914 mm) galvanized steel that is nailed to each wall or segment of wall by six 8d nails or equivalent, provided the rafters, joists or trusses are centered over the studs with a tolerance of no more than 1 inch (25 mm).

Where bearing studs are spaced at 24-inch (610 mm) intervals and top plates are less than two 2-inch by 6-inch (51 mm by 152 mm) or two 3-inch by 4-inch (76 mm by 102 mm) members and where the floor joists, floor trusses or roof trusses that they support are spaced at more than 16-inch (406 mm) intervals, such joists or trusses shall bear within 5 inches (127 mm) of the studs beneath or a third plate shall be installed.

**2308.5.4 Nonbearing walls and partitions.** In nonbearing walls and partitions, studs shall be spaced not more than 28 inches (711 mm) on center and in interior nonbearing walls and partitions, are permitted to be set with the long dimension parallel to the wall. Interior nonbearing partitions shall be capped with no less than a single top plate installed to provide overlapping at corners and at intersections with other walls and partitions. The plate shall be continuously tied at joints by solid blocking at least 16 inches (406 mm) in length and equal in size to the plate or by 1/2-inch by 1 1/2-inch (12.7 mm by 38 mm) metal ties with spliced sections fastened with two 16d nails on each side of the joint.

**2308.5.5 Openings in walls and partitions.** Openings in exterior and interior walls and partitions shall comply with Sections 2308.5.5.1 through 2308.5.5.3

**2308.5.5.1 Headers.** Headers shall be provided over each opening in exterior bearing walls. The size and spans in Table 2308.4.1(1) are permitted to be used for one- and two-family *dwelling*s. Headers for other build-

ings shall be designed in accordance with Section 2301.2, Item 1 or 2. Headers shall be of two pieces of nominal 2-inch (51mm) framing lumber set on edge as permitted by Table 2308.4.1(1) and nailed together in accordance with Table 2304.9.1 or of solid lumber of equivalent size.

**2308.5.5.1.1 Header support.** Wall studs shall support the ends of the header in accordance with Table 2308.4.1(1). Each end of a lintel or header shall have a bearing length of not less than 1 1/2 inches (38 mm) for the full width of the lintel.

**2308.5.5.2 Openings in interior bearing partitions.** Headers shall be provided over each opening in interior bearing partitions as required in Section 2308.5.5.1. The spans in Table 2308.4.1(2) are permitted to be used. Wall studs shall support the ends of the header in accordance with Table 2308.4.1(1) or 2308.4.1(2), as appropriate.

**2308.5.5.3 Openings in interior nonbearing partitions.** Openings in nonbearing partitions are permitted to be framed with single studs and headers. Each end of a lintel or header shall have a bearing length of not less than 1 1/2 inches (38 mm) for the full width of the lintel.

**2308.5.6 Cripple walls.** Foundation cripple walls shall be framed of studs not less in size than the studding above with a minimum length of 14 inches (356 mm) or shall be framed of solid blocking. Where exceeding 4 feet (1219 mm) in height, such walls shall be framed of studs having the size required for an additional *story*. See Section 2308.6.6 for cripple wall bracing.

**2308.5.7 Bridging.** Unless covered by interior or *exterior wall coverings* or sheathing meeting the minimum requirements of this code, stud partitions or walls with studs having a height-to-least-thickness ratio exceeding 50 shall have bridging not less than 2 inches (51 mm) in thickness and of the same width as the studs fitted snugly and nailed thereto to provide adequate lateral support. Bridging shall be placed in every stud cavity and at a frequency such that no stud so braced shall have a height-to-least-thickness

ratio exceeding 50 with the height of the stud measured between horizontal framing and bridging or between bridging, whichever is greater.

**2308.5.8 Pipes in walls.** Stud partitions containing plumbing, heating or other pipes shall be so framed and the joists underneath so spaced as to give proper clearance for the piping. Where a partition containing such piping runs parallel to the floor joists, the joists underneath such partitions shall be doubled and spaced to *permit* the passage of such pipes and shall be bridged. Where plumbing, heating or other pipes are placed in or partly in a partition, necessitating the cutting of the soles or plates, a metal tie not less than 0.058 inch (1.47 mm) (16 galvanized gage) and 1½ inches (38 mm) wide shall be fastened to each plate across and to each side of the opening with not less than six 16d nails.

**2308.5.9 Cutting and notching.** In exterior walls and bearing partitions, any wood stud is permitted to be cut or notched to a depth not exceeding 25 percent of its width. Cutting or notching of studs to a depth not greater than 40 percent of the width of the stud is permitted in nonbearing partitions supporting no loads other than the weight of the partition.

**2308.5.10 Bored holes.** A hole not greater in diameter than 40 percent of the stud width is permitted to be bored in any wood stud. Bored holes not greater than 60 percent of the width of the stud are permitted in nonbearing partitions or in any wall where each bored stud is doubled, provided not more than two such successive doubled studs are so bored.

In no case shall the edge of the bored hole be nearer than ⅝ inch (15.9 mm) to the edge of the stud.

Bored holes shall not be located at the same section of stud as a cut or notch.

|| **2308.6 Wall bracing.** Buildings shall be provided with exterior and interior braced wall lines as described in Sections 2308.6.1 through 2308.6.9.

|| **2308.6.1 Braced wall lines.** For the purpose of determining the amount and location of bracing required along each story level of a building, *braced wall lines* shall be designated as straight lines through the building plan in both the longitudinal and transverse direction and placed in accordance with Table 2308.6.1 and Figure 2308.6(1). *Braced wall line* spacing shall not exceed the distance specified in

Table 2308.6.1. In structures assigned to Seismic Design Category D or E, braced wall lines shall intersect perpendicularly to each other.

**2308.6.2 Braced wall panels.** *Braced wall panels* shall be placed along *braced wall lines* in accordance with Table 2308.6.1 and Figure 2308.6(1) and specified in Table 2308.6.3(1). A *braced wall panel* must be located at each end of the braced wall line and at the corners of intersecting *braced wall lines* or may begin within the maximum distance from the end of the *braced wall line* in accordance with Table 2308.6(1). *Braced wall panels* in a *braced wall line* shall not be offset from each other by more than 4 feet (1219 mm). Braced wall panels shall be clearly indicated on the plans.

**2308.6.3 Braced wall panel methods.** Construction of *braced wall panels* shall be by one or a combination of the methods in Table 2308.6.3(1). *Braced wall panel* length shall be in accordance with Section 2308.6.4 or 2308.6.5.

**2308.6.4 Length of braced wall panels.** For Methods DWB, WSP, SFB, PBS, PCP and HPS, each panel must be at least 48 inches (1219 mm) in length, covering three stud spaces where studs are spaced 16 inches (406 mm) apart and covering two stud spaces where studs are spaced 24 inches (610 mm) apart. *Braced wall panels* less than the required 48-inch (1219 mm) length shall not contribute towards the amount of bracing required. *Braced wall panels* longer than the required length shall be credited for their actual length. For Method GB, each panel must be at least 96 inches (2438 mm) in length where applied to one side of the studs or 48 inches (1219 mm) where applied to both sides.

All vertical joints of panel sheathing shall occur over studs and adjacent panel joints shall be nailed to common framing members. Horizontal joints shall occur over blocking or other framing equal in size to the studding except where waived by the installation requirements for the specific sheathing materials. Sole plates shall be nailed to the floor framing in accordance with Section 2308.6.7 and top plates shall be connected to the framing above in accordance with Section 2308.5.3. Where joists are perpendicular to braced wall lines above, blocking shall be provided under and in line with the *braced wall panels*.

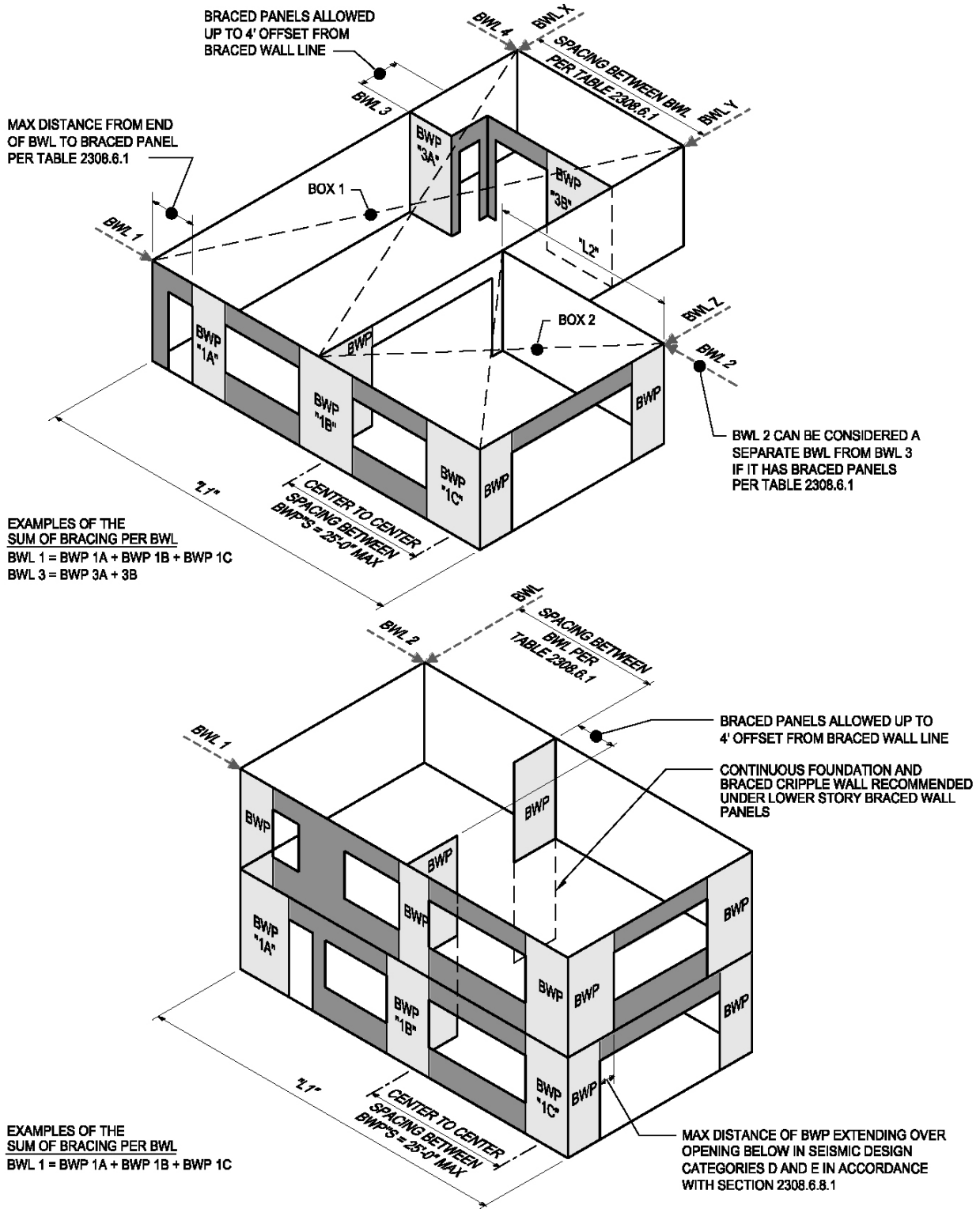





For SI: 1 foot = 304.8 mm.

BWL = BRACED WALL LINE, BWP = BRACED WALL PANEL

FIGURE 2308.6(1)  
 BASIC COMPONENTS OF THE LATERAL BRACING SYSTEM

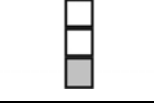
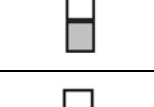
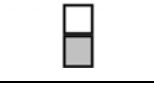
**TABLE 2308.6.1  
WALL BRACING REQUIREMENTS<sup>a,b</sup>**

SEISMIC DESIGN CATEGORY	STORY CONDITION (See section 2308.2)	MAXIMUM SPACING OF BRACED WALL LINES	BRACED PANEL LOCATION, SPACING (o.c.) AND MINIMUM PERCENTAGE (x)			MAXIMUM DISTANCE OF BRACED WALL PANELS FROM EACH END OF BRACED WALL LINE
			Bracing Method			
			LIB	DWB, WSP	SFB, PBS, PCP, HPS, GB <sup>c,d</sup>	
A and B		35'-0"	Each end and ≤ 25'-0" o.c.	Each end and ≤ 25'-0" o.c.	Each end and ≤ 25'-0" o.c.	12'-6"
		35'-0"	Each end and ≤ 25'-0" o.c.	Each end and ≤ 25'-0" o.c.	Each end and ≤ 25'-0" o.c.	12'-6"
		35'-0"	NP	Each end and ≤ 25'-0" o.c.	Each end and ≤ 25'-0" o.c.	12'-6"
C		35'-0"	NP	Each end and ≤ 25'-0" o.c.	Each end and ≤ 25'-0" o.c.	12'-6"
		35'-0"	NP	Each end and ≤ 25'-0" o.c. (min 25% of wall length) <sup>e</sup>	Each end and ≤ 25'-0" o.c. (min 25% of wall length) <sup>e</sup>	12'-6"
D and E		25'-0"	NP	$S_{DS} < 0.50$ : Each end and ≤ 25'-0" o.c. (min 21% of wall length) <sup>e</sup>	$S_{DS} < 0.50$ : Each end and ≤ 25'-0" o.c. (min 43% of wall length) <sup>e</sup>	8'-0"
				$0.5 \leq S_{DS} < 0.75$ : Each end and ≤ 25'-0" o.c. (min 32% of wall length) <sup>e</sup>	$0.5 \leq S_{DS} < 0.75$ : Each end and ≤ 25'-0" o.c. (min 59% of wall length) <sup>e</sup>	
				$0.75 \leq S_{DS} \leq 1.00$ : Each end and ≤ 25'-0" o.c. (min 37% of wall length) <sup>e</sup>	$0.75 \leq S_{DS} \leq 1.00$ : Each end and ≤ 25'-0" o.c. (min 75% of wall length) <sup>e</sup>	
				$S_{DS} > 1.00$ : Each end and ≤ 25'-0" o.c. (min 48% of wall length) <sup>e</sup>	$S_{DS} > 1.00$ : Each end and ≤ 25'-0" o.c. (min 100% of wall length) <sup>e</sup>	

For SI: 1 inch = 25.4 mm, 1 foot = 304.8 mm.

NP = Not Permitted.

a. This table specifies minimum requirements for *braced wall panels* along interior or exterior *braced wall lines*.











b. See Section 2308.6.2 for full description of bracing methods.

c. For method GB, gypsum wallboard applied to framing supports that are spaced at 16 inches on center.

d. The required lengths shall be doubled for gypsum board applied to only one face of a braced wall panel.

e. Percentage shown represents the minimum amount of bracing required along the building length (or wall length if the structure has an irregular shape).

**TABLE 2308.6.3(1)  
BRACING METHODS**

METHODS, MATERIAL	MINIMUM THICKNESS	FIGURE	CONNECTION CRITERIA <sup>a</sup>	
			Fasteners	Spacing
<b>LIB<sup>a</sup></b> Let-in-bracing	1 × 4 wood or approved metal straps at 45° to 60° angles for maximum 16" o.c.		Per fastener Table 2304.9.1	Wood: per stud plus top and bottom plates
			Metal strap: installed per manufacturer's installation recommendations	Metal strap: installed per manufacturer's installation recommendation
<b>DWB</b> Diagonal wood boards	<sup>3</sup> / <sub>4</sub> " thick (1" nominal) × 6" minimum width to studs at maximum of 24" o.c.		Per fastener Table 2304.9.1	Per stud
<b>WSP</b> Wood structural panel	<sup>3</sup> / <sub>8</sub> " Per Table 2308.6.3(2) or 2308.6.3(3)		Per fastener Table 2304.9.1	6" edges 12" field
<b>SFB</b> Structural fiberboard sheathing	<sup>1</sup> / <sub>2</sub> " Per Table 2304.9.1 to studs at maximum 16" o.c.		Per fastener Table 2304.9.1	3" edges 6" field
<b>GB</b> Gypsum board (Double-sided)	<sup>1</sup> / <sub>2</sub> " by a minimum of 4 feet wide to studs at maximum of 24" o.c.		Exterior and interior sheathing: with 5d cooler nails (1 <sup>5</sup> / <sub>8</sub> " × 0.086") or 1 <sup>1</sup> / <sub>4</sub> " screws (type W or S) for <sup>1</sup> / <sub>2</sub> " gypsum board or 1 <sup>5</sup> / <sub>8</sub> " screws (type W or S) for <sup>5</sup> / <sub>8</sub> " gypsum board.	For all braced wall panel locations: 7" o.c. along panel edges (including top and bottom plates) and 7" o.c. in the field
<b>PBS</b> Particleboard sheathing	<sup>3</sup> / <sub>8</sub> " or <sup>1</sup> / <sub>2</sub> " per Table 2308.6.3(4) to studs at maximum of 16" o.c.		6d common (2" long × 0.113" dia.) nails for <sup>3</sup> / <sub>8</sub> " thick sheathing or 8d common (2 <sup>1</sup> / <sub>2</sub> " long × 0.131" dia.) nails for <sup>1</sup> / <sub>2</sub> " thick sheathing	3" edges 6" field
<b>PCP</b> Portland cement plaster	See Section 2510 to studs at maximum of 16" o.c.		1 <sup>1</sup> / <sub>2</sub> " long, 11 gage, <sup>7</sup> / <sub>16</sub> " dia. head nails or <sup>7</sup> / <sub>8</sub> " long, 16 gage staples	6" o.c. on all framing members
<b>HPS</b> Hardboard panel siding	<sup>7</sup> / <sub>16</sub> " Table 2308.6.3(5)		Per fastener Table 2304.9.1	4" edges 8" field
<b>ABW</b> Alternate braced wall	<sup>3</sup> / <sub>8</sub> "		See Figure 2308.6.5(1) and Section 2308.6.5.1	See Figure 2308.6.5(1)
<b>PFH</b> Portal frame with hold-downs	<sup>3</sup> / <sub>8</sub> "		See Figure 2308.6.5(2) and Section 2308.6.5.2	See Figure 2308.6.5(2)

For SI: 1 foot = 305 mm.

a. Method LIB shall have gypsum board fastened to at least one side with nails or screws.



**TABLE 2308.6.3(2)**  
**EXPOSED PLYWOOD PANEL SIDING**

MINIMUM THICKNESS <sup>a</sup> (inch)	MINIMUM NUMBER OF PLYS	STUD SPACING (inches)
		Plywood siding applied directly to studs or over sheathing
$\frac{3}{8}$	3	16 <sup>b</sup>
$\frac{1}{2}$	4	24

For SI: 1 inch = 25.4 mm.

- a. Thickness of grooved panels is measured at bottom of grooves.
- b. Spans are permitted to be 24 inches if plywood siding applied with face grain perpendicular to studs or over one of the following: (1) 1-inch board sheathing, (2)  $\frac{7}{16}$ -inch wood structural panel sheathing or (3)  $\frac{3}{8}$ -inch wood structural panel sheathing with strength axis (which is the long direction of the panel unless otherwise marked) of sheathing perpendicular to studs.

**TABLE 2308.6.3(3)**  
**WOOD STRUCTURAL PANEL WALL SHEATHING<sup>b</sup>**  
**(Not Exposed to the Weather, Strength Axis Parallel or Perpendicular to Studs Except as Indicated Below)**

MINIMUM THICKNESS (inch)	PANEL SPAN RATING	STUD SPACING (inches)		
		Siding nailed to studs	Nailable sheathing	
			Sheathing parallel to studs	Sheathing perpendicular to studs
$\frac{3}{8}$ , $\frac{15}{32}$ , $\frac{1}{2}$	16/0, 20/0, 24/0, 32/16 Wall—24" o.c.	24	16	24
$\frac{7}{16}$ , $\frac{15}{32}$ , $\frac{1}{2}$	24/0, 24/16, 32/16 Wall—24" o.c.	24	24 <sup>a</sup>	24

For SI: 1 inch = 25.4 mm.

- a. Plywood shall consist of four or more plies.
- b. Blocking of horizontal joints shall not be required except as specified in Sections 2306.3 and 2308.12.4.

**TABLE 2308.6.3(4)**  
**ALLOWABLE SPANS FOR PARTICLEBOARD WALL SHEATHING**  
**(Not Exposed to the Weather, Long Dimension of the Panel Parallel or Perpendicular to Studs)**

GRADE	THICKNESS (inch)	STUD SPACING (inches)	
		Siding nailed to studs	Sheathing under coverings specified in Section 2308.9.3 parallel or perpendicular to studs
M-S "Exterior Glue" and M-2 "Exterior Glue"	$\frac{3}{8}$	16	—
	$\frac{1}{2}$	16	16

For SI: 1 inch = 25.4 mm.

**TABLE 2308.6.3(5)  
HARDBOARD SIDING**

SIDING	MINIMUM NOMINAL THICKNESS (inch)	2 x 4 FRAMING MAXIMUM SPACING	NAIL SIZE <sup>a, b, d</sup>	NAIL SPACING	
				General	Bracing panels <sup>e</sup>
<b>1. Lap siding</b>					
Direct to studs	$\frac{3}{8}$	16" o.c.	8d	16" o.c.	Not applicable
Over sheathing	$\frac{3}{8}$	16" o.c.	10d	16" o.c.	Not applicable
<b>2. Square edge panel siding</b>					
Direct to studs	$\frac{3}{8}$	24" o.c.	6d	6" o.c. edges; 12" o.c. at intermediate supports	4" o.c. edges; 8" o.c. at intermediate supports
Over sheathing	$\frac{3}{8}$	24" o.c.	8d	6" o.c. edges; 12" o.c. at intermediate supports	4" o.c. edges; 8" o.c. at intermediate supports
<b>3. Shiplap edge panel siding</b>					
Direct to studs	$\frac{3}{8}$	16" o.c.	6d	6" o.c. edges; 12" o.c. at intermediate supports	4" o.c. edges; 8" o.c. at intermediate supports
Over sheathing	$\frac{3}{8}$	16" o.c.	8d	6" o.c. edges; 12" o.c. at intermediate supports	4" o.c. edges; 8" o.c. at intermediate supports

For SI: 1 inch = 25.4 mm.

a. Nails shall be corrosion resistant.

b. Minimum acceptable nail dimensions:

	Panel Siding (inch)	Lap Siding (inch)
Shank diameter	0.092	0.099
Head diameter	0.225	0.240

c. Where used to comply with Section 2308.6.

d. Nail length must accommodate the sheathing and penetrate framing 1½ inches.

**2308.6.5 Alternative bracing.** An alternate braced wall (ABW) or a portal frame with hold-downs (PFH), as described in this section is permitted to substitute for a 48-inch (1219 mm) braced wall panel of methods DWB, WSP, SFB, PBS, PCP or HPS. For method GB, each 96-inch (2438 mm) section (applied to one face) or 48-inch (1219 mm) section (applied to both faces) or portion thereof required by Table 2308.6.1 is permitted to be replaced by one panel constructed in accordance with method ABW or PFH.

**2308.6.5.1 Alternate braced wall (ABW).** An ABW shall be constructed in accordance with this section and Figure 2308.6.5.1. In one-story buildings, each panel shall have a length of not less than 2 feet 8 inches (813 mm) and a height of not more than 10 feet (3048 mm). Each panel shall be sheathed on one face with  $\frac{3}{8}$ -inch-minimum-thickness (9.5 mm) wood structural panel sheathing nailed with 8d common or galvanized box nails in accordance with Table 2304.9.1 and blocked at wood structural panel edges. Two anchor bolts installed in accordance with Section 2308.3.1 shall be provided in each panel. Anchor bolts shall be placed at each panel outside quarter points. Each panel end stud shall have a hold-down device fastened to the foundation, capable of providing an *approved* uplift capacity of not less than 1,800 pounds (8006 N). The

hold-down device shall be installed in accordance with the manufacturer's recommendations. The ABW shall be supported directly on a foundation or on floor framing supported directly on a foundation that is continuous across the entire length of the braced wall line. This foundation shall be reinforced with not less than one No. 4 bar top and bottom. Where the continuous foundation is required to have a depth greater than 12 inches (305 mm), a minimum 12-inch by 12-inch (305 mm by 305 mm) continuous footing or turned down slab edge is permitted at door openings in the braced wall line. This continuous footing or turned down slab edge shall be reinforced with not less than one No. 4 bar top and bottom. This reinforcement shall be lapped 15 inches (381 mm) with the reinforcement required in the continuous foundation located directly under the braced wall line.

When the ABW is installed at the first *story* of two-story buildings, the wood structural panel sheathing shall be provided on both faces, three anchor bolts shall be placed at one-quarter points and tie-down device uplift capacity shall not be less than 3,000 pounds (13 344 N).

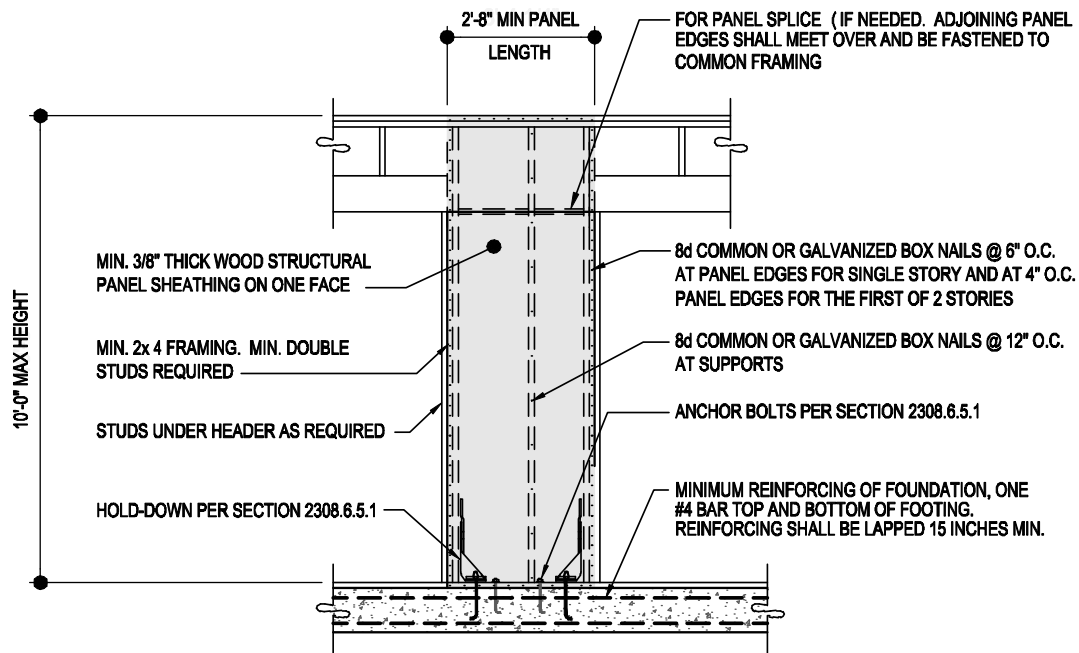

FIGURE 2308.6.5.1  
ALTERNATE BRACED WALL PANEL (ABW)

**2308.6.5.2 Portal frame with hold-downs (PFH).** A PFH shall be constructed in accordance with this section and Figure 2308.6.5.2. The adjacent door or window opening shall have a full-length header.

In one-story buildings, each panel shall have a length of not less than 16 inches (406 mm) and a height of not more than 10 feet (3048 mm). Each panel shall be sheathed on one face with a single layer of  $\frac{3}{8}$ -inch (9.5 mm) minimum thickness wood structural panel sheathing nailed with 8d common or galvanized box nails in accordance with Figure 2308.6.5.2. The wood structural panel sheathing shall extend up over the solid sawn or glued-laminated header and shall be nailed in accordance with Figure 2308.6.5.2. A built-up header consisting of at least two  $2 \times 12$ s and fastened in accordance with Item 24 of Table 2304.9.1 shall be permitted to be used. A spacer, if used, shall be placed on the side of the built-up beam opposite the wood structural panel sheathing. The header shall extend between the inside faces of the first full-length outer studs of each panel. The clear span of the header between the inner studs of each panel shall be not less than 6 feet (1829 mm) and not more than 18 feet (5486 mm) in length. A strap with an uplift capacity of not less than 1,000 pounds (4,400 N) shall fasten the header to the inner studs opposite the sheathing. One anchor bolt not less than  $\frac{5}{8}$  inch (15.9 mm) diameter and installed in accordance with Section 2308.3.1 shall be provided in the center of each sill plate. The studs at each end of the panel shall have a hold-down device fastened to the

foundation with an uplift capacity of not less than 3,500 pounds (15 569 N).

Where a panel is located on one side of the opening, the header shall extend between the inside face of the first full-length stud of the panel and the bearing studs at the other end of the opening. A strap with an uplift capacity of not less than 1,000 pounds (4400 N) shall fasten the header to the bearing studs. The bearing studs shall also have a hold-down device fastened to the foundation with an uplift capacity of not less than 1,000 pounds (4400 N). The hold-down devices shall be an embedded strap type, installed in accordance with the manufacturer's recommendations. The PFH panels shall be supported directly on a foundation that is continuous across the entire length of the braced wall line. This foundation shall be reinforced with not less than one No. 4 bar top and bottom. Where the continuous foundation is required to have a depth greater than 12 inches (305 mm), a minimum 12-inch by 12-inch (305 mm by 305 mm) continuous footing or turned down slab edge is permitted at door openings in the braced wall line. This continuous footing or turned down slab edge shall be reinforced with not less than one No. 4 bar top and bottom. This reinforcement shall be lapped not less than 15 inches (381 mm) with the reinforcement required in the continuous foundation located directly under the braced wall line.

When a PFH is installed at the first story of two-story buildings, each panel shall have a length of not less than 24 inches (610 mm).

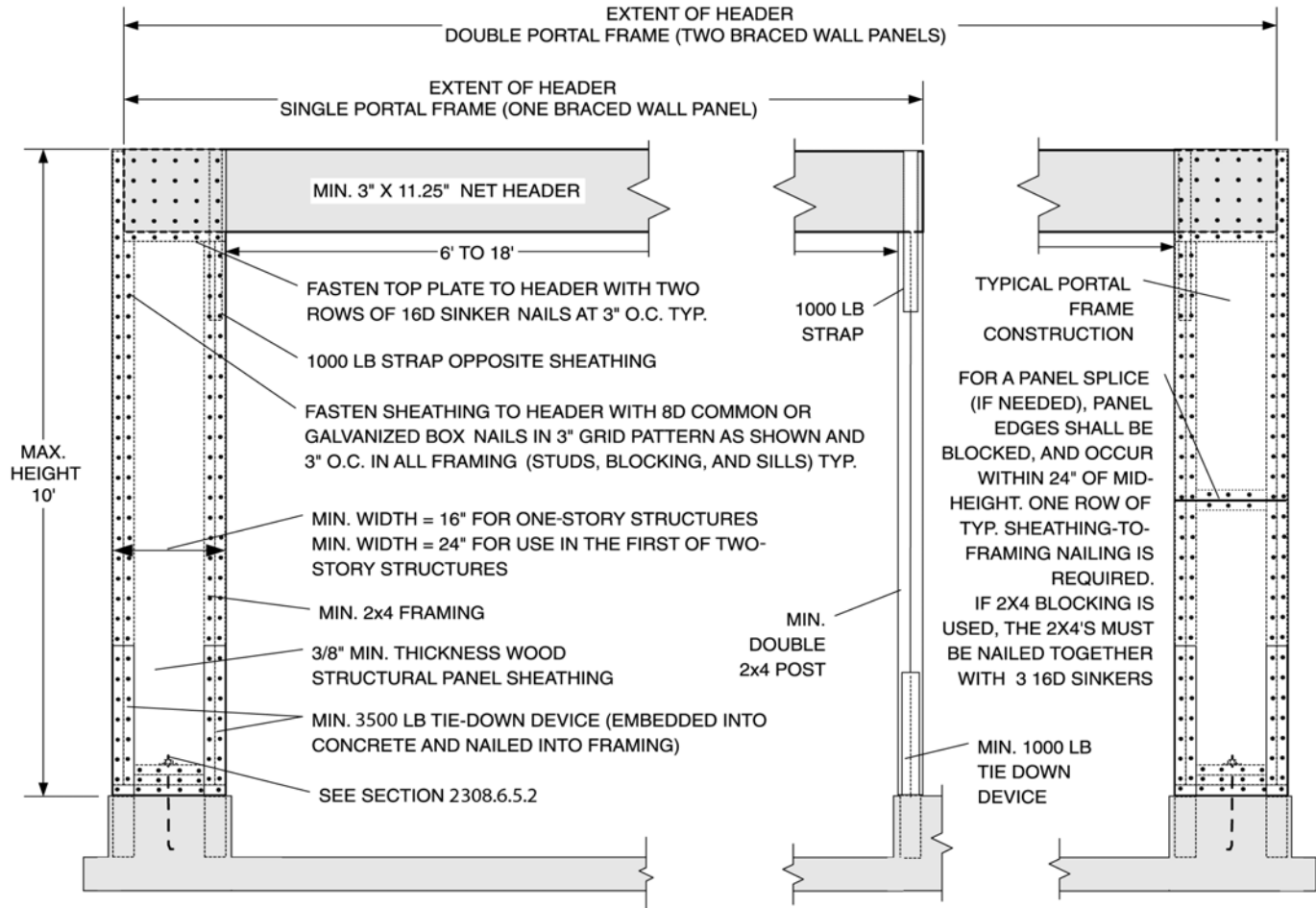

For SI: 1 foot = 304.8 mm; 1 inch = 25.4 mm; 1 pound = 4.448 N.

FIGURE 2308.6.5.2  
PORTAL FRAME WITH HOLD-DOWNS (PFH)

**2308.6.6 Cripple wall bracing.** Cripple walls shall be braced in accordance with the following.

**2308.6.6.1 Cripple wall bracing in Seismic Design Category A, B and C.** For the purposes of this section, cripple walls in *Seismic Design Categories A, B and C* having a stud height exceeding 14 inches (356 mm) shall be considered a *story* and shall be braced in accordance with Table 2308.6(1). Spacing of edge nailing for required cripple wall bracing shall not exceed 6 inches (152 mm) on center along the foundation plate and the top plate of the cripple wall. Nail size, nail spacing for field nailing and more restrictive boundary nailing requirements shall be as required elsewhere in the code for the specific bracing material used.

**2308.6.6.2 Cripple wall bracing in Seismic Design Category D and E.** For the purposes of this section, cripple walls in *Seismic Design Category D and E* having a stud height exceeding 14 inches (356 mm) shall be considered a *story* and shall be braced in accordance

with Table 2308.6.1. Where interior braced wall lines occur without a continuous foundation below, the length of parallel exterior cripple wall bracing shall be one and one-half times the lengths required by Table 2308.6.1. Where the cripple wall sheathing type used is method WSP or DWB and this additional length of bracing cannot be provided, the capacity of WSP or DWB sheathing shall be increased by reducing the spacing of fasteners along the perimeter of each piece of sheathing to 4 inches (102 mm) on center.

**2308.6.7 Connections of braced wall panels.** Braced wall panel joints shall occur over studs or blocking. *Braced wall panels* shall be fastened to studs, top and bottom plates and at panel edges. *Braced wall panels* shall be applied to nominal 2-inch-wide [actual 1½ inch (38 mm)] or larger stud framing.

**2308.6.7.1 Bottom plate connection.** Braced wall line bottom plates shall be connected to joists or full-depth

blocking below in accordance with Table 2304.9.1, or to foundations in accordance with Section 2308.3.1.

**2308.6.7.2 Top plate connection.** Where joists and/or rafters are used, braced wall line top plates shall be fastened over the full length of the braced wall line to joists, rafters, rim boards or full-depth blocking above in accordance with Table 2304.9.1, as applicable, based on the orientation of the joists or rafters to the braced wall line. Blocking at joists with walls above shall be equal to the depth of the joist at the braced wall line. Blocking shall be a minimum of 2 inches (51 mm) nominal thickness and shall be fastened to the braced wall line top plate as specified in Table 2304.9.1. Notching or drilling of holes in blocking in accordance with the requirements of Section 2308.4.2.4 or Section 2308.7.4 shall be permitted.

At exterior gable end walls braced wall panel sheathing in the top story shall be extended and fastened to roof framing where the spacing between parallel exterior braced wall lines is greater than 50 feet (15 240 mm).

Where roof trusses are used and are installed perpendicular to an exterior braced wall line, lateral forces shall be transferred from the roof diaphragm to the

braced wall over the full length of the braced wall line by blocking of the ends of the trusses or by other *approved* methods providing equivalent lateral force transfer. Blocking shall be minimum 2 inches (51 mm) nominal thickness and equal to the depth of the truss at the wall line and shall be fastened to the braced wall line top plate as specified in Table 2304.9.1. Notching or drilling of holes in blocking in accordance with the requirements of Section 2308.4.2.4 or Section 2308.7.4 shall be permitted.

**Exception:** Where the roof sheathing is greater than 9<sup>1</sup>/<sub>4</sub> inches (235 mm) above the top plate, solid blocking is not required when the framing members are connected in accordance with one of the following methods:

1. In accordance with Figure 2308.6.7.2 (1).
2. In accordance with Figure 2308.6.7.2 (2).
3. With full height engineered blocking panels designed for values listed in American Forest and Paper Association's (AF&PA) *Wood Frame Construction Manual for One- and Two-Family Dwellings* (WFCM).
4. Designed in accordance with accepted engineering methods.

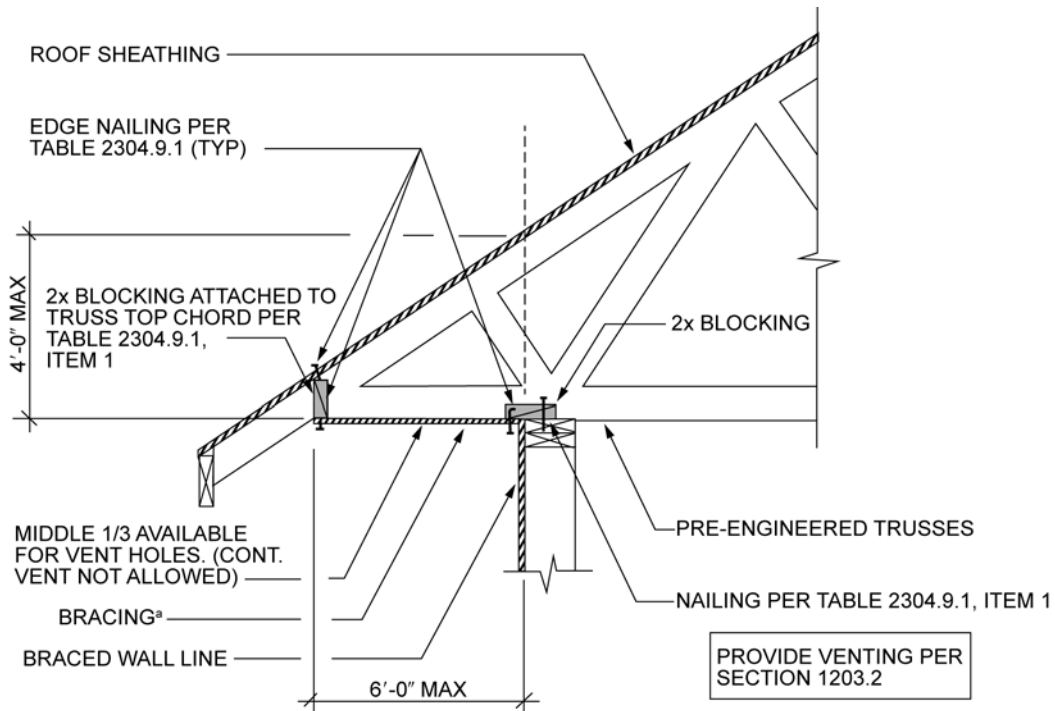

a. Methods of bracing shall be as described in Table 2308.6.3(1) DWB, WSP, SFB, GB, PBS, PCP or HPS.

FIGURE 2308.6.7.2(1)

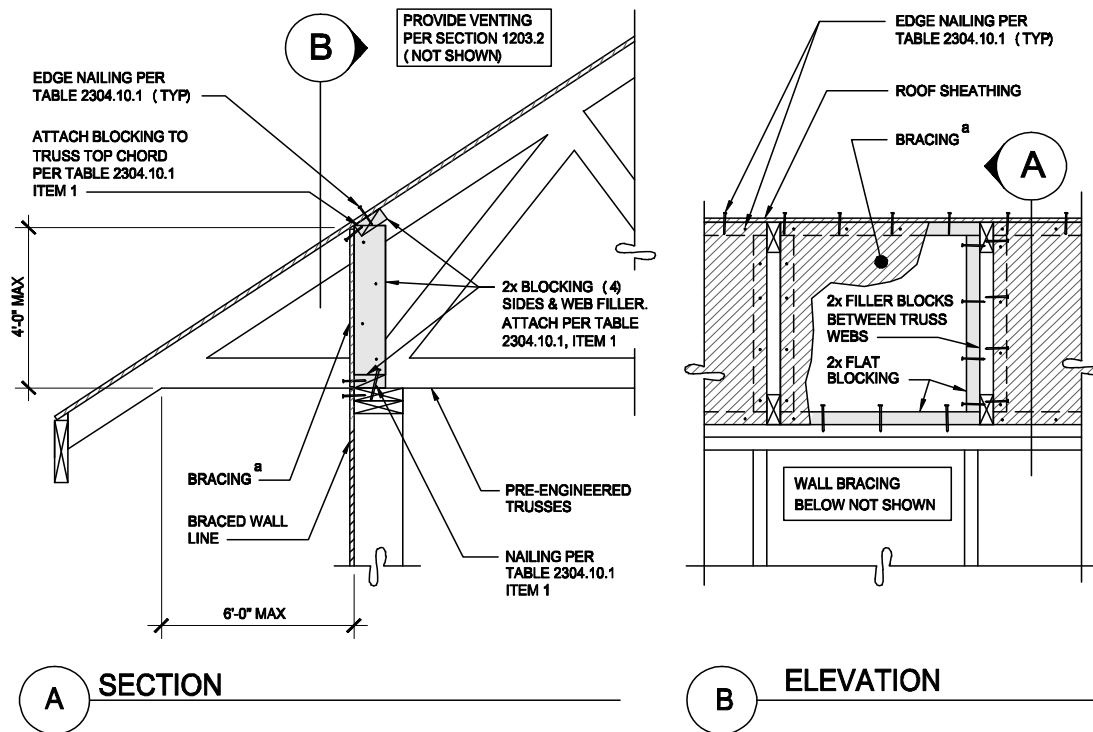

a. Methods of bracing shall be as described in Table 2308.6.3 (1) DWB, WSP, SFB, GB, PBS, PCP or HPS.

FIGURE 2308.6.7.2(2)

**2308.6.7.3 Sill anchorage.** Where foundations are required by Section 2308.6.8, braced wall line sills shall be anchored to concrete or masonry foundations. Such anchorage shall conform to the requirements of Section 2308.3. The anchors shall be distributed along the length of the braced wall line. Other anchorage devices having equivalent capacity are permitted.

**2308.6.7.4 Anchorage to all-wood foundations.** Where all-wood foundations are used, the force transfer from the braced wall lines shall be determined based on calculation and shall have a capacity greater than or equal to the connections required by Section 2308.3.

**2308.6.8 Braced wall line and diaphragm support.** Braced wall lines and floor and roof diaphragms shall be supported in accordance to this section.

**2308.6.8.1 Foundation requirements.** Braced wall lines shall be supported by continuous foundations.

**Exception:** For structures with a maximum plan dimension not over 50 feet (15 240 mm), continuous foundations are required at exterior walls only.

For structures in *Seismic Design Category D* and *E*, exterior *braced wall panels* shall be in the same plane vertically with the foundation or the portion of the structure containing the offset shall be designed in accordance with accepted engineering practice according to Section 2308.1.1

**Exceptions:**

1. Exterior *braced wall panels* may be located up to 4 feet (1219 mm) from the foundation

below when supported by a floor constructed in accordance with all of the following:

- a. Cantilevers or setbacks shall not exceed four times the nominal depth of the floor joists.
  - b. Floor joists shall be 2 inches by 10 inches (51 mm by 254 mm) or larger and spaced not more than 16 inches (406 mm) on center.
  - c. The ratio of the back span to the cantilever shall be at least 2:1.
  - d. Floor joists at ends of *braced wall panels* shall be doubled.
  - e. A continuous rim joist shall be connected to the ends of cantilevered joists. The rim joist is permitted to be spliced using a metal tie not less than 0.058 inch (1.47 mm) (16 galvanized gage) and 1½ inches (38 mm) wide fastened with six 16d common nails on each side. The metal tie shall have a minimum yield stress of 33,000 psi (227 MPa).
  - f. Joists at setbacks or the end of cantilevered joists shall not carry gravity loads from more than a single *story* having uniform wall and roof loads, nor carry the reactions from headers having a span of 8 feet (2438 mm) or more.
2. The end of a required braced wall panel shall be allowed to extend not more than 1 foot (305

mm) over an opening in the wall below. This requirement is applicable to *braced wall panels* offset in plane and to *braced wall panels* offset out of plane as permitted by the exception to Item 1 of this section.

**Exception:** *Braced wall panels* are permitted to extend over an opening not more than 8 feet (2438 mm) in width where the header is a 4-inch by 12-inch (102 mm by 305 mm) or larger member.

**2308.6.8.2 Floor and roof diaphragm support in Seismic Design Category D and E.** In structures assigned to *Seismic Design Category D* or *E*, floor and roof diaphragms shall be laterally supported by braced wall lines on all edges and connected in accordance with Section 2308.6.7.

**Exception:** Portions of roofs or floors that do not support *braced wall panels* above are permitted to extend up to 6 feet (1829 mm) beyond a braced wall line [see Figure 2308.6.7.2(2)] provided that the framing members are connected to the braced wall line below in accordance with Section 2308.6.6.

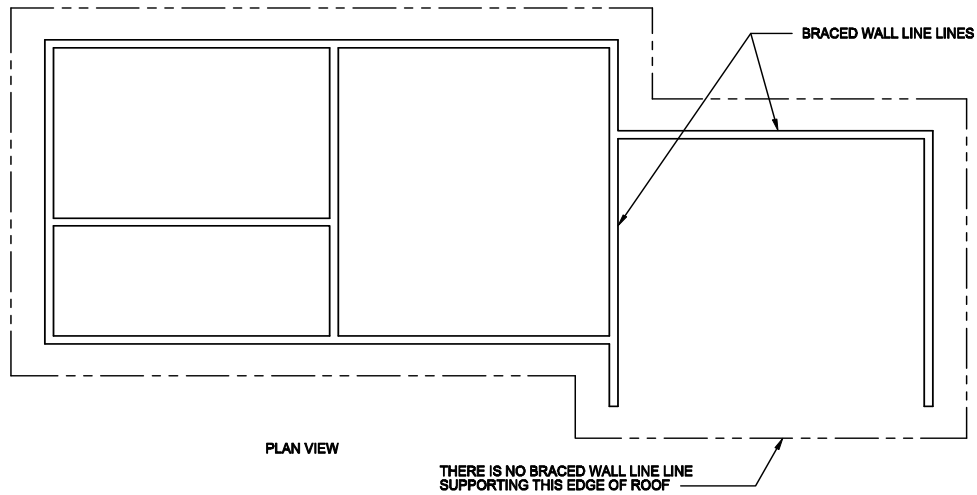

For SI: 1 foot = 304.8 mm.

**FIGURE 2308.6.8.2(1)**  
**ROOF IN SDC D OR E NOT SUPPORTED ON ALL EDGES**

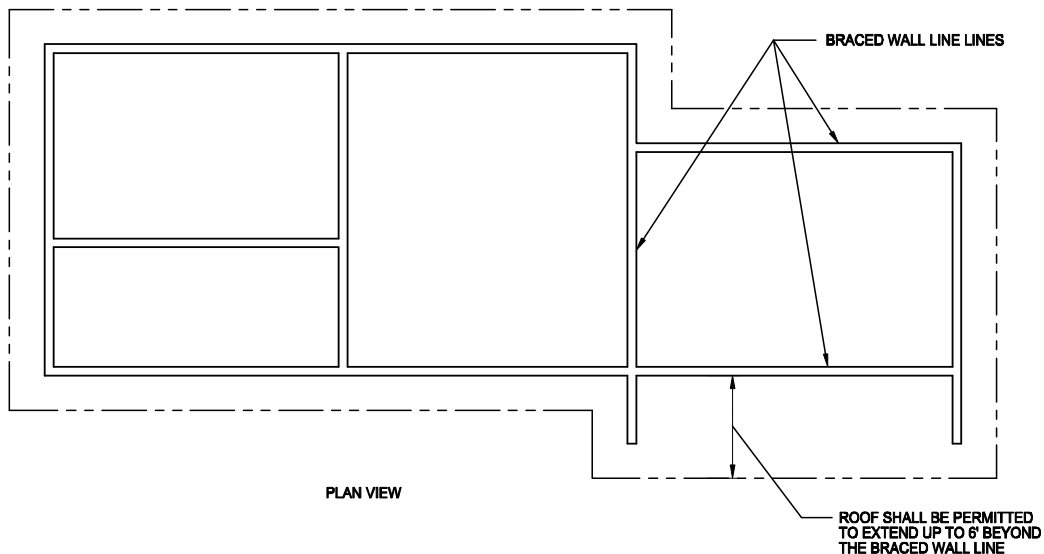

For SI: 1 foot = 304.8 mm.

**FIGURE 2308.6.8.2(2)**  
**ROOF EXTENSION IN SDC D OR E BEYOND BRACED WALL LINE**

**2308.6.8.3 Stepped footings in Seismic Design Category B, C, D and E.** In *Seismic Design Category B, C, D and E*, where the height of a required braced wall panel extending from foundation to floor above varies more than 4 feet (1219 mm), the following construction shall be used:

1. Where the bottom of the footing is stepped and the lowest floor framing rests directly on a sill bolted to the footings, the sill shall be anchored as required in Section 2308.3.
2. Where the lowest floor framing rests directly on a sill bolted to a footing not less than 8 feet (2438 mm) in length along a line of bracing, the line shall be considered to be braced. The double plate of the cripple stud wall beyond the segment of footing extending to the lowest framed floor shall be spliced to the sill plate with metal ties, one on each side of the sill and plate. The metal ties shall not be less than 0.058 inch [1.47 mm (16 galvanized gage)] by 1½ inches (38 mm) wide by 48 inches (1219 mm) with eight 16d common nails on each side of the splice location (see Figure 2308.6.8.3(1)). The metal tie shall have a minimum yield stress of 33,000 pounds per square inch (psi) (227 MPa).
3. Where cripple walls occur between the top of the footing and the lowest floor framing, the bracing requirements for a *story* shall apply.

**2308.6.9 Attachment of sheathing.** Fastening of braced wall panel sheathing shall not be less than that prescribed in Tables 2308.6.1 and 2304.9.1. Wall sheathing shall not be attached to framing members by adhesives.

**2308.6.10 Limitations of concrete or masonry veneer.** Concrete or masonry veneer shall comply with Chapter 14 and this section.

**2308.6.10.1 Limitations of concrete or masonry veneer in Seismic Design Categories B or C.** In *Seismic Design Category B and C*, concrete or masonry walls and stone or masonry veneer shall not extend above a basement.

**Exceptions:**

1. In structures assigned to *Seismic Design Category B*, stone and masonry veneer is permitted to be used in the first two stories above grade plane or the first three stories above grade plane where the lowest *story* has concrete or masonry walls, provided that structural use panel wall bracing is used and the length of bracing provided is one and one-half times the required length as determined in Table 2308.6.1.
2. Stone and masonry veneer is permitted to be used in the first *story* above grade plane or the first two stories above grade plane where the lowest *story* has concrete or masonry walls.
3. Stone and masonry veneer is permitted to be used in both stories of buildings with two stories above grade plane, provided the following criteria are met:
  - 3.1. Type of brace in accordance with Section 2308.6.1 shall be WSP and the allowable shear capacity in accordance with Section 2306.3 shall be a minimum of 350 plf (5108 N/m).

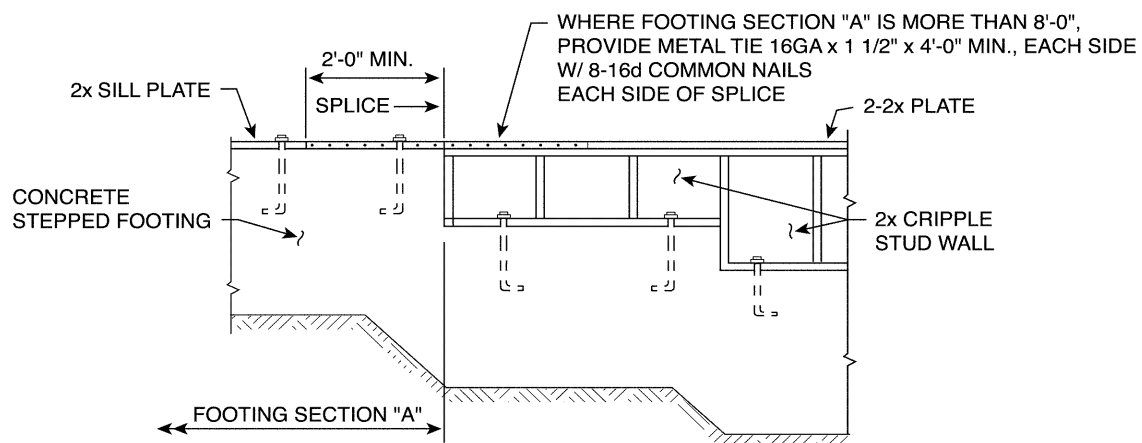

**NOTE:** WHERE FOOTING SECTION "A" IS LESS THAN 8'-0" LONG IN A 25'-0" TOTAL LENGTH WALL, PROVIDE BRACING AT CRIPPLE STUD WALL

For SI: 1 inch = 25.4 mm, 1 foot = 304.8 mm.

**FIGURE 2308.6.8.3(1)**  
**STEPPED FOOTING CONNECTION DETAILS**



- 3.2. *Braced wall panels* in the second *story* shall be located in accordance with Section 2308.6.1 and not more than 25 feet (7620 mm) on center, and the total length of braced wall panels shall be not less than 25 percent of the braced wall line length. *Braced wall panels* in the first *story* shall be located in accordance with Section 2308.6.1 and not more than 25 feet (7620 mm) on center, and the total length of *braced wall panels* shall be not less than 45 percent of the braced wall line length.
- 3.3. Hold-down connectors shall be provided at the ends of each *braced wall panel* for the second *story* to first *story* connection with an allowable capacity of 2,000 pounds (8896 N). Hold-down connectors shall be provided at the ends of each *braced wall panel* for the first *story* to foundation connection with an allowable capacity of 3,900 pounds (17 347 N). In all cases, the hold-down connector force shall be transferred to the foundation.
- 3.4. Cripple walls shall not be permitted.

**2308.6.10.2 Limitations of concrete or masonry in Seismic Design Categories D and E.** In *Seismic Design Category D* and *E* concrete or masonry walls and stone or masonry veneer shall not extend above a basement.

**Exception:** In structures assigned to *Seismic Design Category D*, stone and masonry veneer is permitted to be used in the first *story* above grade plane, provided the following criteria are met:

1. Type of brace in accordance with Section 2308.6.1 shall be WSP and the allowable shear capacity in accordance with Section 2306.3 shall be a minimum of 350 plf (5108 N/m).
2. The bracing of the first *story* shall be located at each end and at least every 25 feet (7620 mm) on center but not less than 45 percent of the braced wall line.
3. Hold-down connectors shall be provided at the ends of braced walls for the first floor to foundation with an allowable capacity of 2,100 pounds (9341 N).
4. Cripple walls shall not be permitted.

**2308.7 Roof and ceiling framing.** The framing details required in this section apply to roofs having a minimum slope of three units vertical in 12 units horizontal (25-percent slope) or greater. Where the roof slope is less than three units vertical in 12 units horizontal (25-percent slope), members supporting rafters and ceiling joists such as ridge board, hips and valleys shall be designed as beams.

**2308.7.1 Ceiling joist spans.** Allowable spans for ceiling joists shall be in accordance with Table 2308.7.1(1) or 2308.7.1(2). For other grades and species, refer to the *AF&PA Span Tables for Joists and Rafters*.

**2308.7.2 Rafter spans.** Allowable spans for rafters shall be in accordance with Table 2308.7.2(1), 2308.7.2(2), 2308.7.2(3), 2308.7.2(4), 2308.7.2(5) or 2308.7.2(6). For other grades and species, refer to the *AF&PA Span Tables for Joists and Rafters*.

**2308.7.3 Ceiling joist and rafter framing.** Rafters shall be framed directly opposite each other at the ridge. There shall be a ridge board at least 1-inch (25 mm) nominal thickness at ridges and not less in depth than the cut end of the rafter. At valleys and hips, there shall be a single valley or hip rafter not less than 2-inch (51 mm) nominal thickness and not less in depth than the cut end of the rafter.

**2308.7.3.1 Ceiling joist and rafter connections.** Ceiling joists and rafters shall be nailed to each other and the assembly shall be nailed to the top wall plate in accordance with Tables 2304.9.1 and 2308.7.5. Ceiling joists shall be continuous or securely joined where they meet over interior partitions and be fastened to adjacent rafters in accordance with Tables 2304.9.1 and 2308.7.3.1 to provide a continuous rafter tie across the building where such joists are parallel to the rafters. Ceiling joists shall have a bearing surface of not less than 1½ inches (38 mm) on the top plate at each end.

Where ceiling joists are not parallel to rafters, an equivalent rafter tie shall be installed in a manner to provide a continuous tie across the building, at a spacing of not more than 4 feet (1219 mm) on center. The connections shall be in accordance with Tables 2308.7.3.1 and 2304.9.1, or connections of equivalent capacities shall be provided. Where ceiling joists or rafter ties are not provided at the top of the rafter support walls, the ridge formed by these rafters shall also be supported by a girder conforming to Section 2308.2.7. Rafter ties shall be spaced not more than 4 feet (1219 mm) on center.

Rafter tie connections shall be based on the equivalent rafter spacing in Table 2308.7.3.1. Rafter/ceiling joist connections and rafter/tie connections shall be of sufficient size and number to prevent splitting from nailing.

Roof framing member connections to braced wall lines shall be in accordance with 2308.6.6.2.

**2308.7.4 Notches and holes.** Notching at the ends of rafters or ceiling joists shall not exceed one-fourth the depth. Notches in the top or bottom of the rafter or ceiling joist shall not exceed one-sixth the depth and shall not be located in the middle one-third of the span, except that a notch not exceeding one-third of the depth is permitted in the top of the rafter or ceiling joist not further from the face of the support than the depth of the member. Holes bored in rafters or ceiling joists shall not be within 2 inches (51 mm) of the top and bottom and their diameter shall not exceed one-third the depth of the member.

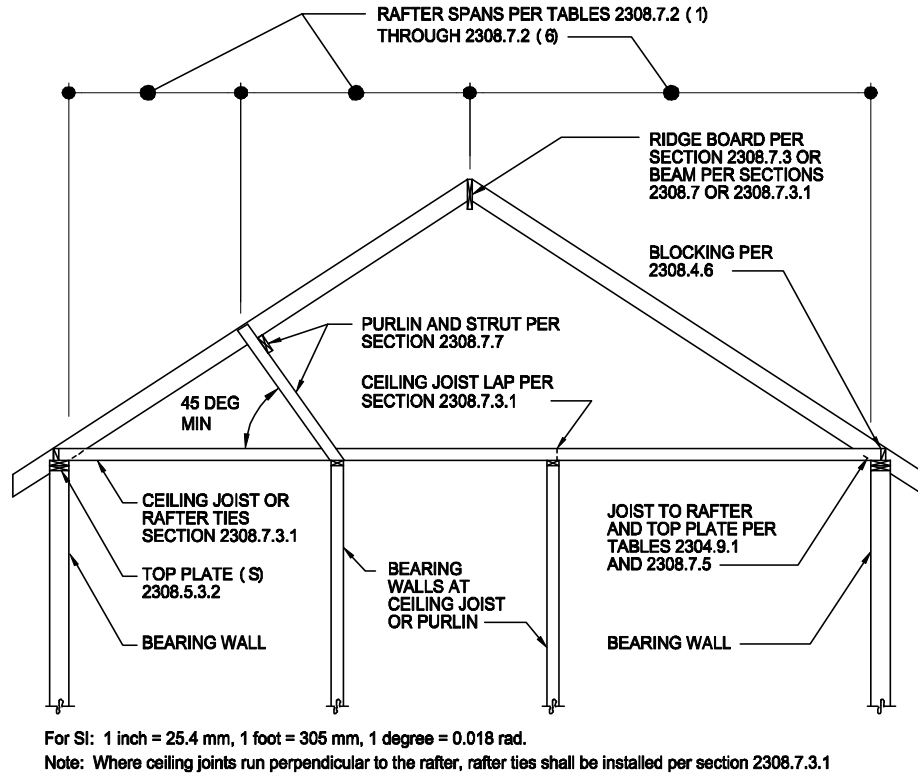

For SI: 1 inch = 25.4 mm, 1 foot = 304.8 mm.

FIGURE 2308.7  
ROOF CEILING FRAMING

**2308.7.5 Wind uplift.** The roof construction shall have rafter and truss ties to the wall below. Resultant uplift loads shall be transferred to the foundation using a continuous load path. The rafter or truss to wall connection shall comply with Tables 2304.9.1 and 2308.7.5.

**2308.7.6 Framing around openings.** Trimmer and header rafters shall be doubled, or of lumber of equivalent cross section, where the span of the header exceeds 4 feet (1219 mm). The ends of header rafters more than 6 feet (1829 mm) long shall be supported by framing anchors or rafter hangers unless bearing on a beam, partition or wall.

**2308.7.6.1 Openings in roof diaphragms in Seismic Design Categories B, C, D and E.** Openings in horizontal diaphragms with a dimension perpendicular to the joist that is greater than 4 feet (1219 mm) shall be constructed with metal ties and blocking in accordance with this section and Figure 2308.4.4.1(1). Metal ties shall not be less than 0.058 inch [1.47 mm (16 galvanized gage)] thick by 1½ inches (38 mm) wide with a minimum yield stress of 33,000 psi (227 Mpa). Blocking shall be provided 2 feet (610 mm) minimum beyond headers. Ties shall be attached to blocking with eight 16d common nails on each side of the header-joist intersection.

**2308.7.7 Purlins.** Purlins to support roof loads are permitted to be installed to reduce the span of rafters within allowable limits and shall be supported by struts to bearing walls. The maximum span of 2-inch by 4-inch (51 mm by 102 mm) purlins shall be 4 feet (1219 mm). The maximum span of the 2-inch by 6-inch (51 mm by 152 mm) purlin shall be 6 feet (1829 mm), but in no case shall the purlin be smaller than the supported rafter. Struts shall not be smaller than 2-inch by 4-inch (51 mm by 102 mm) members. The unbraced length of struts shall not exceed 8 feet (2438 mm) and the minimum slope of the struts shall not be less than 45 degrees (0.79 rad) from the horizontal.

**2308.7.8 Blocking.** Roof rafters and ceiling joists shall be supported laterally to prevent rotation and lateral displacement in accordance with the provisions of Section 2308.4.6 and connected to braced wall lines per Section 2308.6.7.2.

**2308.7.9 Engineered wood products.** Prefabricated wood I-joists, structural glued-laminated timber and structural composite lumber shall not be notched or drilled except where permitted by the manufacturer's recommendations or where the effects of such alterations are specifically considered in the design of the member by a *registered design professional*.

**2308.7.10 Roof sheathing.** Roof sheathing shall be in accordance with Tables 2304.7(3) and 2304.7(5) for wood structural panels, and Tables 2304.7(1) and 2304.7(2) for lumber and shall comply with Section 2304.7.2.

**2308.7.11 Joints.** Joints in lumber sheathing shall occur over supports unless *approved* end-matched lumber is used, in which case each piece shall bear on at least two supports.

**2308.7.12 Roof planking.** Planking shall be designed in accordance with the general provisions of this code.

In lieu of such design, 2-inch (51 mm) tongue-and-groove planking is permitted in accordance with Table 2308.7.12. Joints in such planking are permitted to be randomly spaced, provided the system is applied to not less than three continuous spans, planks are center matched and end matched or splined, each plank bears on at least one support, and joints are separated by at least 24 inches (610 mm) in adjacent pieces.

**2308.7.13 Wood trusses.** Wood trusses shall be designed in accordance with Section 2303.4. Connection to braced wall lines shall be in accordance with 2308.6.7.2.

**2308.7.14 Attic ventilation.** For *attic* ventilation, see Section 1203.2.

**2308.8 Design of elements.** Combining of engineered elements or systems and conventionally specified elements or systems shall be permitted subject to the following limits.

**2308.8.1 Elements exceeding limitations of conventional construction.** When a building of otherwise conventional construction contains structural elements exceeding the limits of Section 2308.2, these elements and the supporting load path shall be designed in accordance with accepted engineering practice and the provisions of this code.

**2308.8.2 Structural elements or systems not described herein.** When a building of otherwise conventional construction contains structural elements or systems not described in Section 2308, these elements or systems shall be designed in accordance with accepted engineering practice and the provisions of this code. The extent of such design need only demonstrate compliance of the nonconventional elements with other applicable provisions of this code and shall be compatible with the performance of the conventionally framed system.

**TABLE 2308.7.1(1)**  
**CEILING JOIST SPANS FOR COMMON LUMBER SPECIES**  
 (Uninhabitable Attics Without Storage, Live Load = 10 pounds psf,  $L/\Delta = 240$ )

CEILING JOIST SPACING (inches)	SPECIES AND GRADE		DEAD LOAD = 5 pounds per square foot			
			2 x 4	2 x 6	2 x 8	2 x 10
			Maximum ceiling joist spans			
			(ft. - in.)	(ft. - in.)	(ft. - in.)	(ft. - in.)
12	Douglas Fir-Larch	SS	13-2	20-8	26-0	26-0
	Douglas Fir-Larch	#1	12-8	19-11	26-0	26-0
	Douglas Fir-Larch	#2	12-5	19-6	25-8	26-0
	Douglas Fir-Larch	#3	10-10	15-10	20-1	24-6
	Hem-Fir	SS	12-5	19-6	25-8	26-0
	Hem-Fir	#1	12-2	19-1	25-2	26-0
	Hem-Fir	#2	11-7	18-2	24-0	26-0
	Hem-Fir	#3	10-10	15-10	20-1	24-6
	Southern Pine	SS	12-11	20-3	26-0	26-0
	Southern Pine	#1	12-8	19-11	26-0	26-0
	Southern Pine	#2	12-5	19-6	25-8	26-0
	Southern Pine	#3	11-6	17-0	21-8	25-7
	Spruce-Pine-Fir	SS	12-2	19-1	25-2	26-0
	Spruce-Pine-Fir	#1	11-10	18-8	24-7	26-0
	Spruce-Pine-Fir	#2	11-10	18-8	24-7	26-0
	Spruce-Pine-Fir	#3	10-10	15-10	20-1	24-6
16	Douglas Fir-Larch	SS	11-11	18-9	24-8	26-0
	Douglas Fir-Larch	#1	11-6	18-1	23-10	26-0
	Douglas Fir-Larch	#2	11-3	17-8	23-0	26-0
	Douglas Fir-Larch	#3	9-5	13-9	17-5	21-3
	Hem-Fir	SS	11-3	17-8	23-4	26-0
	Hem-Fir	#1	11-0	17-4	22-10	26-0
	Hem-Fir	#2	10-6	16-6	21-9	26-0
	Hem-Fir	#3	9-5	13-9	17-5	21-3
	Southern Pine	SS	11-9	18-5	24-3	26-0
	Southern Pine	#1	11-6	18-1	23-1	26-0
	Southern Pine	#2	11-3	17-8	23-4	26-0
	Southern Pine	#3	10-0	14-9	18-9	22-2
	Spruce-Pine-Fir	SS	11-0	17-4	22-10	26-0
	Spruce-Pine-Fir	#1	10-9	16-11	22-4	26-0
	Spruce-Pine-Fir	#2	10-9	16-11	22-4	26-0
	Spruce-Pine-Fir	#3	9-5	13-9	17-5	21-3

(continued)

**TABLE 2308.7.1(1)—continued**  
**CEILING JOIST SPANS FOR COMMON LUMBER SPECIES**  
**(Uninhabitable Attics Without Storage, Live Load = 10 pounds psf, L/Δ = 240)**

CEILING JOIST SPACING (inches)	SPECIES AND GRADE		DEAD LOAD = 5 pounds per square foot			
			2 × 4	2 × 6	2 × 8	2 × 10
			Maximum ceiling joist spans			
			(ft. - in.)	(ft. - in.)	(ft. - in.)	(ft. - in.)
19.2	Douglas Fir-Larch	SS	11-3	17-8	23-3	26-0
	Douglas Fir-Larch	#1	10-10	17-0	22-5	26-0
	Douglas Fir-Larch	#2	10-7	16-7	21-0	25-8
	Douglas Fir-Larch	#3	8-7	12-6	15-10	19-5
	Hem-Fir	SS	10-7	16-8	21-11	26-0
	Hem-Fir	#1	10-4	16-4	21-6	26-0
	Hem-Fir	#2	9-11	15-7	20-6	25-3
	Hem-Fir	#3	8-7	12-6	15-10	19-5
	Southern Pine	SS	11-0	17-4	22-10	26-0
	Southern Pine	#1	10-10	17-0	22-5	26-0
	Southern Pine	#2	10-7	16-8	21-11	26-0
	Southern Pine	#3	9-1	13-6	17-2	20-3
	Spruce-Pine-Fir	SS	10-4	16-4	21-6	26-0
	Spruce-Pine-Fir	#1	10-2	15-11	21-0	25-8
	Spruce-Pine-Fir	#2	10-2	15-11	21-0	25-8
	Spruce-Pine-Fir	#3	8-7	12-6	15-10	19-5
24	Douglas Fir-Larch	SS	10-5	16-4	21-7	26-0
	Douglas Fir-Larch	#1	10-0	15-9	20-1	24-6
	Douglas Fir-Larch	#2	9-10	14-10	18-9	22-11
	Douglas Fir-Larch	#3	7-8	11-2	14-2	17-4
	Hem-Fir	SS	9-10	15-6	20-5	26-0
	Hem-Fir	#1	9-8	15-2	19-7	23-11
	Hem-Fir	#2	9-2	14-5	18-6	22-7
	Hem-Fir	#3	7-8	11-2	14-2	17-4
	Southern Pine	SS	10-3	16-1	21-2	26-0
	Southern Pine	#1	10-0	15-9	20-10	26-0
	Southern Pine	#2	9-10	15-6	20-1	23-11
	Southern Pine	#3	8-2	12-0	15-4	18-1
	Spruce-Pine-Fir	SS	9-8	15-2	19-11	25-5
	Spruce-Pine-Fir	#1	9-5	14-9	18-9	22-11
	Spruce-Pine-Fir	#2	9-5	14-9	18-9	22-11
	Spruce-Pine-Fir	#3	7-8	11-2	14-2	17-4

For SI: 1 inch = 25.4 mm, 1 foot = 304.8 mm, 1 pound per square foot = 47.8 N/m<sup>2</sup>.

**TABLE 2308.7.1(2)**  
**CEILING JOIST SPANS FOR COMMON LUMBER SPECIES**  
**(Uninhabitable Attics With Limited Storage, Live Load = 20 pounds per square foot,  $L/\Delta = 240$ )**

CEILING JOIST SPACING (inches)	SPECIES AND GRADE		DEAD LOAD = 10 pounds per square foot			
			2 x 4	2 x 6	2 x 8	2 x 10
			Maximum ceiling joist spans			
			(ft. - in.)	(ft. - in.)	(ft. - in.)	(ft. - in.)
12	Douglas Fir-Larch	SS	10-5	16-4	21-7	26-0
	Douglas Fir-Larch	#1	10-0	15-9	20-1	24-6
	Douglas Fir-Larch	#2	9-10	14-10	18-9	22-11
	Douglas Fir-Larch	#3	7-8	11-2	14-2	17-4
	Hem-Fir	SS	9-10	15-6	20-5	26-0
	Hem-Fir	#1	9-8	15-2	19-7	23-11
	Hem-Fir	#2	9-2	14-5	18-6	22-7
	Hem-Fir	#3	7-8	11-2	14-2	17-4
	Southern Pine	SS	10-3	16-1	21-2	26-0
	Southern Pine	#1	10-0	15-9	20-10	26-0
	Southern Pine	#2	9-10	15-6	20-1	23-11
	Southern Pine	#3	8-2	12-0	15-4	18-1
	Spruce-Pine-Fir	SS	9-8	15-2	19-11	25-5
	Spruce-Pine-Fir	#1	9-5	14-9	18-9	22-11
	Spruce-Pine-Fir	#2	9-5	14-9	18-9	22-11
	Spruce-Pine-Fir	#3	7-8	11-2	14-2	17-4
16	Douglas Fir-Larch	SS	9-6	14-11	19-7	25-0
	Douglas Fir-Larch	#1	9-1	13-9	17-5	21-3
	Douglas Fir-Larch	#2	8-9	12-10	16-3	19-10
	Douglas Fir-Larch	#3	6-8	9-8	12-4	15-0
	Hem-Fir	SS	8-11	14-1	18-6	23-8
	Hem-Fir	#1	8-9	13-5	16-10	20-8
	Hem-Fir	#2	8-4	12-8	16-0	19-7
	Hem-Fir	#3	6-8	9-8	12-4	15-0
	Southern Pine	SS	9-4	14-7	19-3	24-7
	Southern Pine	#1	9-1	14-4	18-11	23-1
	Southern Pine	#2	8-11	13-6	17-5	20-9
	Southern Pine	#3	7-1	10-5	13-3	15-8
	Spruce-Pine-Fir	SS	8-9	13-9	18-1	23-1
	Spruce-Pine-Fir	#1	8-7	12-10	16-3	19-10
	Spruce-Pine-Fir	#2	8-7	12-10	16-3	19-10
	Spruce-Pine-Fir	#3	6-8	9-8	12-4	15-0

(continued)

||

**TABLE 2308.7.1(2)—continued**  
**CEILING JOIST SPANS FOR COMMON LUMBER SPECIES**  
(Uninhabitable Attics With Limited Storage, Live Load = 20 pounds per square foot,  $L/\Delta = 240$ )

CEILING JOIST SPACING (inches)	SPECIES AND GRADE		DEAD LOAD = 10 pounds per square foot			
			2 × 4	2 × 6	2 × 8	2 × 10
			Maximum ceiling joist spans			
			(ft. - in.)	(ft. - in.)	(ft. - in.)	(ft. - in.)
19.2	Douglas Fir-Larch	SS	8-11	14-0	18-5	23-4
	Douglas Fir-Larch	#1	8-7	12-6	15-10	19-5
	Douglas Fir-Larch	#2	8-0	11-9	14-10	18-2
	Douglas Fir-Larch	#3	6-1	8-10	11-3	13-8
	Hem-Fir	SS	8-5	13-3	17-5	22-3
	Hem-Fir	#1	8-3	12-3	15-6	18-11
	Hem-Fir	#2	7-10	11-7	14-8	17-10
	Hem-Fir	#3	6-1	8-10	11-3	13-8
	Southern Pine	SS	8-9	13-9	18-1	23-1
	Southern Pine	#1	8-7	13-6	17-9	21-1
	Southern Pine	#2	8-5	12-3	15-10	18-11
	Southern Pine	#3	6-5	9-6	12-1	14-4
	Spruce-Pine-Fir	SS	8-3	12-11	17-1	21-8
	Spruce-Pine-Fir	#1	8-0	11-9	14-10	18-2
	Spruce-Pine-Fir	#2	8-0	11-9	14-10	18-2
	Spruce-Pine-Fir	#3	6-1	8-10	11-3	13-8
24	Douglas Fir-Larch	SS	8-3	13-0	17-1	20-11
	Douglas Fir-Larch	#1	7-8	11-2	14-2	17-4
	Douglas Fir-Larch	#2	7-2	10-6	13-3	16-3
	Douglas Fir-Larch	#3	5-5	7-11	10-0	12-3
	Hem-Fir	SS	7-10	12-3	16-2	20-6
	Hem-Fir	#1	7-6	10-11	13-10	16-11
	Hem-Fir	#2	7-1	10-4	13-1	16-0
	Hem-Fir	#3	5-5	7-11	10-0	12-3
	Southern Pine	SS	8-1	12-9	16-10	21-6
	Southern Pine	#1	8-0	12-6	15-10	18-10
	Southern Pine	#2	7-8	11-0	14-2	16-11
	Southern Pine	#3	5-9	8-6	10-10	12-10
	Spruce-Pine-Fir	SS	7-8	12-0	15-10	19-5
	Spruce-Pine-Fir	#1	7-2	10-6	13-3	16-3
	Spruce-Pine-Fir	#2	7-2	10-6	13-3	16-3
	Spruce-Pine-Fir	#3	5-5	7-11	10-0	12-3

For SI: 1 inch = 25.4 mm, 1 foot = 304.8 mm, 1 pound per square foot = 47.8 N/m<sup>2</sup>.

**TABLE 2308.7.2(1)**  
**RAFTER SPANS FOR COMMON LUMBER SPECIES**  
 (Roof Live Load = 20 pounds per square foot, Ceiling Not Attached to Rafters,  $L/\Delta = 180$ )

RAFTER SPACING (inches)	SPECIES AND GRADE		DEAD LOAD = 10 pounds per square foot					DEAD LOAD = 20 pounds per square foot				
			2 x 4	2 x 6	2 x 8	2 x 10	2 x 12	2 x 4	2 x 6	2 x 8	2 x 10	2 x 12
			Maximum rafter spans									
			(ft. - in.)	(ft. - in.)	(ft. - in.)	(ft. - in.)	(ft. - in.)	(ft. - in.)	(ft. - in.)	(ft. - in.)	(ft. - in.)	(ft. - in.)
12	Douglas Fir-Larch	SS	11-6	18-0	23-9	26-0	26-0	11-6	18-0	23-5	26-0	26-0
	Douglas Fir-Larch	#1	11-1	17-4	22-5	26-0	26-0	10-6	15-4	19-5	23-9	26-0
	Douglas Fir-Larch	#2	10-10	16-7	21-0	25-8	26-0	9-10	14-4	18-2	22-3	25-9
	Douglas Fir-Larch	#3	8-7	12-6	15-10	19-5	22-6	7-5	10-10	13-9	16-9	19-6
	Hem-Fir	SS	10-10	17-0	22-5	26-0	26-0	10-10	17-0	22-5	26-0	26-0
	Hem-Fir	#1	10-7	16-8	21-10	26-0	26-0	10-3	14-11	18-11	23-2	26-0
	Hem-Fir	#2	10-1	15-11	20-8	25-3	26-0	9-8	14-2	17-11	21-11	25-5
	Hem-Fir	#3	8-7	12-6	15-10	19-5	22-6	7-5	10-10	13-9	16-9	19-6
	Southern Pine	SS	11-3	17-8	23-4	26-0	26-0	11-3	17-8	23-4	26-0	26-0
	Southern Pine	#1	11-1	17-4	22-11	26-0	26-0	11-1	17-3	21-9	25-10	26-0
	Southern Pine	#2	10-10	17-0	22-5	26-0	26-0	10-6	15-1	19-5	23-2	26-0
	Southern Pine	#3	9-1	13-6	17-2	20-3	24-1	7-11	11-8	14-10	17-6	20-11
	Spruce-Pine-Fir	SS	10-7	16-8	21-11	26-0	26-0	10-7	16-8	21-9	26-0	26-0
	Spruce-Pine-Fir	#1	10-4	16-3	21-0	25-8	26-0	9-10	14-4	18-2	22-3	25-9
	Spruce-Pine-Fir	#2	10-4	16-3	21-0	25-8	26-0	9-10	14-4	18-2	22-3	25-9
	Spruce-Pine-Fir	#3	8-7	12-6	15-10	19-5	22-6	7-5	10-10	13-9	16-9	19-6
16	Douglas Fir-Larch	SS	10-5	16-4	21-7	26-0	26-0	10-5	16-0	20-3	24-9	26-0
	Douglas Fir-Larch	#1	10-0	15-4	19-5	23-9	26-0	9-1	13-3	16-10	20-7	23-10
	Douglas Fir-Larch	#2	9-10	14-4	18-2	22-3	25-9	8-6	12-5	15-9	19-3	22-4
	Douglas Fir-Larch	#3	7-5	10-10	13-9	16-9	19-6	6-5	9-5	11-11	14-6	16-10
	Hem-Fir	SS	9-10	15-6	20-5	26-0	26-0	9-10	15-6	19-11	24-4	26-0
	Hem-Fir	#1	9-8	14-11	18-11	23-2	26-0	8-10	12-11	16-5	20-0	23-3
	Hem-Fir	#2	9-2	14-2	17-11	21-11	25-5	8-5	12-3	15-6	18-11	22-0
	Hem-Fir	#3	7-5	10-10	13-9	16-9	19-6	6-5	9-5	11-11	14-6	16-10
	Southern Pine	SS	10-3	16-1	21-2	26-0	26-0	10-3	16-1	21-2	26-0	26-0
	Southern Pine	#1	10-0	15-9	20-10	25-10	26-0	10-0	15-0	18-10	22-4	26-0
	Southern Pine	#2	9-10	15-1	19-5	23-2	26-0	9-1	13-0	16-10	20-1	23-7
	Southern Pine	#3	7-11	11-8	14-10	17-6	20-11	6-10	10-1	12-10	15-2	18-1
	Spruce-Pine-Fir	SS	9-8	15-2	19-11	25-5	26-0	9-8	14-10	18-10	23-0	26-0
	Spruce-Pine-Fir	#1	9-5	14-4	18-2	22-3	25-9	8-6	12-5	15-9	19-3	22-4
	Spruce-Pine-Fir	#2	9-5	14-4	18-2	22-3	25-9	8-6	12-5	15-9	19-3	22-4
	Spruce-Pine-Fir	#3	7-5	10-10	13-9	16-9	19-6	6-5	9-5	11-11	14-6	16-10

(continued)



**TABLE 2308.7.2(1)—continued**  
**RAFTER SPANS FOR COMMON LUMBER SPECIES**  
**(Roof Live Load = 20 pounds per square foot, Ceiling Not Attached to Rafters,  $L/\Delta = 180$ )**

RAFTER SPACING (inches)	SPECIES AND GRADE		DEAD LOAD = 10 pounds per square foot					DEAD LOAD = 20 pounds per square foot				
			2 x 4	2 x 6	2 x 8	2 x 10	2 x 12	2 x 4	2 x 6	2 x 8	2 x 10	2 x 12
			Maximum rafter spans									
			(ft. - in.)	(ft. - in.)	(ft. - in.)	(ft. - in.)	(ft. - in.)	(ft. - in.)	(ft. - in.)	(ft. - in.)	(ft. - in.)	(ft. - in.)
19.2	Douglas Fir-Larch	SS	9-10	15-5	20-4	25-11	26-0	9-10	14-7	18-6	22-7	26-0
	Douglas Fir-Larch	#1	9-5	14-0	17-9	21-8	25-2	8-4	12-2	15-4	18-9	21-9
	Douglas Fir-Larch	#2	8-11	13-1	16-7	20-3	23-6	7-9	11-4	14-4	17-7	20-4
	Douglas Fir-Larch	#3	6-9	9-11	12-7	15-4	17-9	5-10	8-7	10-10	13-3	15-5
	Hem-Fir	SS	9-3	14-7	19-2	24-6	26-0	9-3	14-4	18-2	22-3	25-9
	Hem-Fir	#1	9-1	13-8	17-4	21-1	24-6	8-1	11-10	15-0	18-4	21-3
	Hem-Fir	#2	8-8	12-11	16-4	20-0	23-2	7-8	11-2	14-2	17-4	20-1
	Hem-Fir	#3	6-9	9-11	12-7	15-4	17-9	5-10	8-7	10-10	13-3	15-5
	Southern Pine	SS	9-8	15-2	19-11	25-5	26-0	9-8	15-2	19-11	25-5	26-0
	Southern Pine	#1	9-5	14-10	19-7	23-7	26-0	9-3	13-8	17-2	20-5	24-4
	Southern Pine	#2	9-3	13-9	17-9	21-2	24-10	8-4	11-11	15-4	18-4	21-6
	Southern Pine	#3	7-3	10-8	13-7	16-0	19-1	6-3	9-3	11-9	13-10	16-6
	Spruce-Pine-Fir	SS	9-1	14-3	18-9	23-11	26-0	9-1	13-7	17-2	21-0	24-4
	Spruce-Pine-Fir	#1	8-10	13-1	16-7	20-3	23-6	7-9	11-4	14-4	17-7	20-4
	Spruce-Pine-Fir	#2	8-10	13-1	16-7	20-3	23-6	7-9	11-4	14-4	17-7	20-4
	Spruce-Pine-Fir	#3	6-9	9-11	12-7	15-4	17-9	5-10	8-7	10-10	13-3	15-5
24	Douglas Fir-Larch	SS	9-1	14-4	18-10	23-4	26-0	8-11	13-1	16-7	20-3	23-5
	Douglas Fir-Larch	#1	8-7	12-6	15-10	19-5	22-6	7-5	10-10	13-9	16-9	19-6
	Douglas Fir-Larch	#2	8-0	11-9	14-10	18-2	21-0	6-11	10-2	12-10	15-8	18-3
	Douglas Fir-Larch	#3	6-1	8-10	11-3	13-8	15-11	5-3	7-8	9-9	11-10	13-9
	Hem-Fir	SS	8-7	13-6	17-10	22-9	26-0	8-7	12-10	16-3	19-10	23-0
	Hem-Fir	#1	8-4	12-3	15-6	18-11	21-11	7-3	10-7	13-5	16-4	19-0
	Hem-Fir	#2	7-11	11-7	14-8	17-10	20-9	6-10	10-0	12-8	15-6	17-11
	Hem-Fir	#3	6-1	8-10	11-3	13-8	15-11	5-3	7-8	9-9	11-10	13-9
	Southern Pine	SS	8-11	14-1	18-6	23-8	26-0	8-11	14-1	18-6	22-11	26-0
	Southern Pine	#1	8-9	13-9	17-9	21-1	25-2	8-3	12-3	15-4	18-3	21-9
	Southern Pine	#2	8-7	12-3	15-10	18-11	22-2	7-5	10-8	13-9	16-5	19-3
	Southern Pine	#3	6-5	9-6	12-1	14-4	17-1	5-7	8-3	10-6	12-5	14-9
	Spruce-Pine-Fir	SS	8-5	13-3	17-5	21-8	25-2	8-4	12-2	15-4	18-9	21-9
	Spruce-Pine-Fir	#1	8-0	11-9	14-10	18-2	21-0	6-11	10-2	12-10	15-8	18-3
	Spruce-Pine-Fir	#2	8-0	11-9	14-10	18-2	21-0	6-11	10-2	12-10	15-8	18-3
	Spruce-Pine-Fir	#3	6-1	8-10	11-3	13-8	15-11	5-3	7-8	9-9	11-10	13-9

For SI: 1 inch = 25.4 mm, 1 foot = 304.8 mm, 1 pound per square foot = 47.9 N/m<sup>2</sup>.

**TABLE 2308.7.2(2)**  
**RAFTER SPANS FOR COMMON LUMBER SPECIES**  
 (Roof Live Load = 20 pounds per square foot, Ceiling Attached to Rafters,  $L/\Delta = 240$ )

RAFTER SPACING (inches)	SPECIES AND GRADE		DEAD LOAD = 10 pounds per square foot					DEAD LOAD = 20 pounds per square foot				
			2 x 4	2 x 6	2 x 8	2 x 10	2 x 12	2 x 4	2 x 6	2 x 8	2 x 10	2 x 12
			Maximum rafter spans									
			(ft. - in.)	(ft. - in.)	(ft. - in.)	(ft. - in.)	(ft. - in.)	(ft. - in.)	(ft. - in.)	(ft. - in.)	(ft. - in.)	(ft. - in.)
12	Douglas Fir-Larch	SS	10-5	16-4	21-7	26-0	26-0	10-5	16-4	21-7	26-0	26-0
	Douglas Fir-Larch	#1	10-0	15-9	20-10	26-0	26-0	10-0	15-4	19-5	23-9	26-0
	Douglas Fir-Larch	#2	9-10	15-6	20-5	25-8	26-0	9-10	14-4	18-2	22-3	25-9
	Douglas Fir-Larch	#3	8-7	12-6	15-10	19-5	22-6	7-5	10-10	13-9	16-9	19-6
	Hem-Fir	SS	9-10	15-6	20-5	26-0	26-0	9-10	15-6	20-5	26-0	26-0
	Hem-Fir	#1	9-8	15-2	19-11	25-5	26-0	9-8	14-11	18-11	23-2	26-0
	Hem-Fir	#2	9-2	14-5	19-0	24-3	26-0	9-2	14-2	17-11	21-11	25-5
	Hem-Fir	#3	8-7	12-6	15-10	19-5	22-6	7-5	10-10	13-9	16-9	19-6
	Southern Pine	SS	10-3	16-1	21-2	26-0	26-0	10-3	16-1	21-2	26-0	26-0
	Southern Pine	#1	10-0	15-9	20-10	26-0	26-0	10-0	15-9	20-10	25-10	26-0
	Southern Pine	#2	9-10	15-6	20-5	26-0	26-0	9-10	15-1	19-5	23-2	26-0
	Southern Pine	#3	9-1	13-6	17-2	20-3	24-1	7-11	11-8	14-10	17-6	20-11
	Spruce-Pine-Fir	SS	9-8	15-2	19-11	25-5	26-0	9-8	15-2	19-11	25-5	26-0
	Spruce-Pine-Fir	#1	9-5	14-9	19-6	24-10	26-0	9-5	14-4	18-2	22-3	25-9
	Spruce-Pine-Fir	#2	9-5	14-9	19-6	24-10	26-0	9-5	14-4	18-2	22-3	25-9
	Spruce-Pine-Fir	#3	8-7	12-6	15-10	19-5	22-6	7-5	10-10	13-9	16-9	19-6
16	Douglas Fir-Larch	SS	9-6	14-11	19-7	25-0	26-0	9-6	14-11	19-7	24-9	26-0
	Douglas Fir-Larch	#1	9-1	14-4	18-11	23-9	26-0	9-1	13-3	16-10	20-7	23-10
	Douglas Fir-Larch	#2	8-11	14-1	18-2	22-3	25-9	8-6	12-5	15-9	19-3	22-4
	Douglas Fir-Larch	#3	7-5	10-10	13-9	16-9	19-6	6-5	9-5	11-11	14-6	16-10
	Hem-Fir	SS	8-11	14-1	18-6	23-8	26-0	8-11	14-1	18-6	23-8	26-0
	Hem-Fir	#1	8-9	13-9	18-1	23-1	26-0	8-9	12-11	16-5	20-0	23-3
	Hem-Fir	#2	8-4	13-1	17-3	21-11	25-5	8-4	12-3	15-6	18-11	22-0
	Hem-Fir	#3	7-5	10-10	13-9	16-9	19-6	6-5	9-5	11-11	14-6	16-10
	Southern Pine	SS	9-4	14-7	19-3	24-7	26-0	9-4	14-7	19-3	24-7	26-0
	Southern Pine	#1	9-1	14-4	18-11	24-1	26-0	9-1	14-4	18-10	22-4	26-0
	Southern Pine	#2	8-11	14-1	18-6	23-2	26-0	8-11	13-0	16-10	20-1	23-7
	Southern Pine	#3	7-11	11-8	14-10	17-6	20-11	6-10	10-1	12-10	15-2	18-1
	Spruce-Pine-Fir	SS	8-9	13-9	18-1	23-1	26-0	8-9	13-9	18-1	23-0	26-0
	Spruce-Pine-Fir	#1	8-7	13-5	17-9	22-3	25-9	8-6	12-5	15-9	19-3	22-4
	Spruce-Pine-Fir	#2	8-7	13-5	17-9	22-3	25-9	8-6	12-5	15-9	19-3	22-4
	Spruce-Pine-Fir	#3	7-5	10-10	13-9	16-9	19-6	6-5	9-5	11-11	14-6	16-10

(continued)

**TABLE 2308.7.2(2)—continued**  
**RAFTER SPANS FOR COMMON LUMBER SPECIES**  
 (Roof Live Load = 20 pounds per square foot, Ceiling Attached to Rafters,  $L/\Delta = 240$ )

RAFTER SPACING (inches)	SPECIES AND GRADE		DEAD LOAD = 10 pounds per square foot					DEAD LOAD = 20 pounds per square foot				
			2 x 4	2 x 6	2 x 8	2 x 10	2 x 12	2 x 4	2 x 6	2 x 8	2 x 10	2 x 12
			Maximum rafter spans									
			(ft. - in.)	(ft. - in.)	(ft. - in.)	(ft. - in.)	(ft. - in.)	(ft. - in.)	(ft. - in.)	(ft. - in.)	(ft. - in.)	(ft. - in.)
19.2	Douglas Fir-Larch	SS	8-11	14-0	18-5	23-7	26-0	8-11	14-0	18-5	22-7	26-0
	Douglas Fir-Larch	#1	8-7	13-6	17-9	21-8	25-2	8-4	12-2	15-4	18-9	21-9
	Douglas Fir-Larch	#2	8-5	13-1	16-7	20-3	23-6	7-9	11-4	14-4	17-7	20-4
	Douglas Fir-Larch	#3	6-9	9-11	12-7	15-4	17-9	5-10	8-7	10-10	13-3	15-5
	Hem-Fir	SS	8-5	13-3	17-5	22-3	26-0	8-5	13-3	17-5	22-3	25-9
	Hem-Fir	#1	8-3	12-11	17-1	21-1	24-6	8-1	11-10	15-0	18-4	21-3
	Hem-Fir	#2	7-10	12-4	16-3	20-0	23-2	7-8	11-2	14-2	17-4	20-1
	Hem-Fir	#3	6-9	9-11	12-7	15-4	17-9	5-10	8-7	10-10	13-3	15-5
	Southern Pine	SS	8-9	13-9	18-1	23-1	26-0	8-9	13-9	18-1	23-1	26-0
	Southern Pine	#1	8-7	13-6	17-9	22-8	26-0	8-7	13-6	17-2	20-5	24-4
	Southern Pine	#2	8-5	13-3	17-5	21-2	24-10	8-4	11-11	15-4	18-4	21-6
	Southern Pine	#3	7-3	10-8	13-7	16-0	19-1	6-3	9-3	11-9	13-10	16-6
	Spruce-Pine-Fir	SS	8-3	12-11	17-1	21-9	26-0	8-3	12-11	17-1	21-0	24-4
	Spruce-Pine-Fir	#1	8-1	12-8	16-7	20-3	23-6	7-9	11-4	14-4	17-7	20-4
	Spruce-Pine-Fir	#2	8-1	12-8	16-7	20-3	23-6	7-9	11-4	14-4	17-7	20-4
	Spruce-Pine-Fir	#3	6-9	9-11	12-7	15-4	17-9	5-10	8-7	10-10	13-3	15-5
24	Douglas Fir-Larch	SS	8-3	13-0	17-2	21-10	26-0	8-3	13-0	16-7	20-3	23-5
	Douglas Fir-Larch	#1	8-0	12-6	15-10	19-5	22-6	7-5	10-10	13-9	16-9	19-6
	Douglas Fir-Larch	#2	7-10	11-9	14-10	18-2	21-0	6-11	10-2	12-10	15-8	18-3
	Douglas Fir-Larch	#3	6-1	8-10	11-3	13-8	15-11	5-3	7-8	9-9	11-10	13-9
	Hem-Fir	SS	7-10	12-3	16-2	20-8	25-1	7-10	12-3	16-2	19-10	23-0
	Hem-Fir	#1	7-8	12-0	15-6	18-11	21-11	7-3	10-7	13-5	16-4	19-0
	Hem-Fir	#2	7-3	11-5	14-8	17-10	20-9	6-10	10-0	12-8	15-6	17-11
	Hem-Fir	#3	6-1	8-10	11-3	13-8	15-11	5-3	7-8	9-9	11-10	13-9
	Southern Pine	SS	8-1	12-9	16-10	21-6	26-0	8-1	12-9	16-10	21-6	26-0
	Southern Pine	#1	8-0	12-6	16-6	21-1	25-2	8-0	12-3	15-4	18-3	21-9
	Southern Pine	#2	7-10	12-3	15-10	18-11	22-2	7-5	10-8	13-9	16-5	19-3
	Southern Pine	#3	6-5	9-6	12-1	14-4	17-1	5-7	8-3	10-6	12-5	14-9
	Spruce-Pine-Fir	SS	7-8	12-0	15-10	20-2	24-7	7-8	12-0	15-4	18-9	21-9
	Spruce-Pine-Fir	#1	7-6	11-9	14-10	18-2	21-0	6-11	10-2	12-10	15-8	18-3
	Spruce-Pine-Fir	#2	7-6	11-9	14-10	18-2	21-0	6-11	10-2	12-10	15-8	18-3
	Spruce-Pine-Fir	#3	6-1	8-10	11-3	13-8	15-11	5-3	7-8	9-9	11-10	13-9

For SI: 1 inch = 25.4 mm, 1 foot = 304.8 mm, 1 pound per square foot = 47.9 N/m<sup>2</sup>.

**TABLE 2308.7.2(3)**  
**RAFTER SPANS FOR COMMON LUMBER SPECIES**  
 (Ground Snow Load = 30 pounds per square foot, Ceiling Not Attached to Rafters,  $L/\Delta = 180$ )

RAFTER SPACING (inches)	SPECIES AND GRADE		DEAD LOAD = 10 pounds per square foot					DEAD LOAD = 20 pounds per square foot				
			2 x 4	2 x 6	2 x 8	2 x 10	2 x 12	2 x 4	2 x 6	2 x 8	2 x 10	2 x 12
			Maximum rafter spans									
			(ft. - in.)	(ft. - in.)	(ft. - in.)	(ft. - in.)	(ft. - in.)	(ft. - in.)	(ft. - in.)	(ft. - in.)	(ft. - in.)	(ft. - in.)
12	Douglas Fir-Larch	SS	10-0	15-9	20-9	26-0	26-0	10-0	15-9	20-1	24-6	26-0
	Douglas Fir-Larch	#1	9-8	14-9	18-8	22-9	26-0	9-0	13-2	16-8	20-4	23-7
	Douglas Fir-Larch	#2	9-5	13-9	17-5	21-4	24-8	8-5	12-4	15-7	19-1	22-1
	Douglas Fir-Larch	#3	7-1	10-5	13-2	16-1	18-8	6-4	9-4	11-9	14-5	16-8
	Hem-Fir	SS	9-6	14-10	19-7	25-0	26-0	9-6	14-10	19-7	24-1	26-0
	Hem-Fir	#1	9-3	14-4	18-2	22-2	25-9	8-9	12-10	16-3	19-10	23-0
	Hem-Fir	#2	8-10	13-7	17-2	21-0	24-4	8-4	12-2	15-4	18-9	21-9
	Hem-Fir	#3	7-1	10-5	13-2	16-1	18-8	6-4	9-4	11-9	14-5	16-8
	Southern Pine	SS	9-10	15-6	20-5	26-0	26-0	9-10	15-6	20-5	26-0	26-0
	Southern Pine	#1	9-8	15-2	20-0	24-9	26-0	9-8	14-10	18-8	22-2	26-0
	Southern Pine	#2	9-6	14-5	18-8	22-3	26-0	9-0	12-11	16-8	19-11	23-4
	Southern Pine	#3	7-7	11-2	14-3	16-10	20-0	6-9	10-0	12-9	15-1	17-11
	Spruce-Pine-Fir	SS	9-3	14-7	19-2	24-6	26-0	9-3	14-7	18-8	22-9	26-0
	Spruce-Pine-Fir	#1	9-1	13-9	17-5	21-4	24-8	8-5	12-4	15-7	19-1	22-1
	Spruce-Pine-Fir	#2	9-1	13-9	17-5	21-4	24-8	8-5	12-4	15-7	19-1	22-1
	Spruce-Pine-Fir	#3	7-1	10-5	13-2	16-1	18-8	6-4	9-4	11-9	14-5	16-8
16	Douglas Fir-Larch	SS	9-1	14-4	18-10	23-9	26-0	9-1	13-9	17-5	21-3	24-8
	Douglas Fir-Larch	#1	8-9	12-9	16-2	19-9	22-10	7-10	11-5	14-5	17-8	20-5
	Douglas Fir-Larch	#2	8-2	11-11	15-1	18-5	21-5	7-3	10-8	13-6	16-6	19-2
	Douglas Fir-Larch	#3	6-2	9-0	11-5	13-11	16-2	5-6	8-1	10-3	12-6	14-6
	Hem-Fir	SS	8-7	13-6	17-10	22-9	26-0	8-7	13-6	17-1	20-10	24-2
	Hem-Fir	#1	8-5	12-5	15-9	19-3	22-3	7-7	11-1	14-1	17-2	19-11
	Hem-Fir	#2	8-0	11-9	14-11	18-2	21-1	7-2	10-6	13-4	16-3	18-10
	Hem-Fir	#3	6-2	9-0	11-5	13-11	16-2	5-6	8-1	10-3	12-6	14-6
	Southern Pine	SS	8-11	14-1	18-6	23-8	26-0	8-11	14-1	18-6	23-8	26-0
	Southern Pine	#1	8-9	13-9	18-1	21-5	25-7	8-8	12-10	16-2	19-2	22-10
	Southern Pine	#2	8-7	12-6	16-2	19-3	22-7	7-10	11-2	14-5	17-3	20-2
	Southern Pine	#3	6-7	9-8	12-4	14-7	17-4	5-10	8-8	11-0	13-0	15-6
	Spruce-Pine-Fir	SS	8-5	13-3	17-5	22-1	25-7	8-5	12-9	16-2	19-9	22-10
	Spruce-Pine-Fir	#1	8-2	11-11	15-1	18-5	21-5	7-3	10-8	13-6	16-6	19-2
	Spruce-Pine-Fir	#2	8-2	11-11	15-1	18-5	21-5	7-3	10-8	13-6	16-6	19-2
	Spruce-Pine-Fir	#3	6-2	9-0	11-5	13-11	16-2	5-6	8-1	10-3	12-6	14-6

(continued)

**TABLE 2308.7.2(3)—continued**  
**RAFTER SPANS FOR COMMON LUMBER SPECIES**  
**(Ground Snow Load = 30 pounds per square foot, Ceiling Not Attached to Rafters,  $L/\Delta = 180$ )**

RAFTER SPACING (inches)	SPECIES AND GRADE		DEAD LOAD = 10 pounds per square foot					DEAD LOAD = 20 pounds per square foot				
			2 × 4	2 × 6	2 × 8	2 × 10	2 × 12	2 × 4	2 × 6	2 × 8	2 × 10	2 × 12
			Maximum rafter spans									
			(ft. - in.)	(ft. - in.)	(ft. - in.)	(ft. - in.)	(ft. - in.)	(ft. - in.)	(ft. - in.)	(ft. - in.)	(ft. - in.)	(ft. - in.)
19.2	Douglas Fir-Larch	SS	8-7	13-6	17-9	21-8	25-2	8-7	12-6	15-10	19-5	22-6
	Douglas Fir-Larch	#1	7-11	11-8	14-9	18-0	20-11	7-1	10-5	13-2	16-1	18-8
	Douglas Fir-Larch	#2	7-5	10-11	13-9	16-10	19-6	6-8	9-9	12-4	15-1	17-6
	Douglas Fir-Larch	#3	5-7	8-3	10-5	12-9	14-9	5-0	7-4	9-4	11-5	13-2
	Hem-Fir	SS	8-1	12-9	16-9	21-4	24-8	8-1	12-4	15-7	19-1	22-1
	Hem-Fir	#1	7-9	11-4	14-4	17-7	20-4	6-11	10-2	12-10	15-8	18-2
	Hem-Fir	#2	7-4	10-9	13-7	16-7	19-3	6-7	9-7	12-2	14-10	17-3
	Hem-Fir	#3	5-7	8-3	10-5	12-9	14-9	5-0	7-4	9-4	11-5	13-2
	Southern Pine	SS	8-5	13-3	17-5	22-3	26-0	8-5	13-3	17-5	22-0	25-9
	Southern Pine	#1	8-3	13-0	16-6	19-7	23-4	7-11	11-9	14-9	17-6	20-11
	Southern Pine	#2	7-11	11-5	14-9	17-7	20-7	7-1	10-2	13-2	15-9	18-5
	Southern Pine	#3	6-0	8-10	11-3	13-4	15-10	5-4	7-11	10-1	11-11	14-2
	Spruce-Pine-Fir	SS	7-11	12-5	16-5	20-2	23-4	7-11	11-8	14-9	18-0	20-11
	Spruce-Pine-Fir	#1	7-5	10-11	13-9	16-10	19-6	6-8	9-9	12-4	15-1	17-6
	Spruce-Pine-Fir	#2	7-5	10-11	13-9	16-10	19-6	6-8	9-9	12-4	15-1	17-6
	Spruce-Pine-Fir	#3	5-7	8-3	10-5	12-9	14-9	5-0	7-4	9-4	11-5	13-2
24	Douglas Fir-Larch	SS	7-11	12-6	15-10	19-5	22-6	7-8	11-3	14-2	17-4	20-1
	Douglas Fir-Larch	#1	7-1	10-5	13-2	16-1	18-8	6-4	9-4	11-9	14-5	16-8
	Douglas Fir-Larch	#2	6-8	9-9	12-4	15-1	17-6	5-11	8-8	11-0	13-6	15-7
	Douglas Fir-Larch	#3	5-0	7-4	9-4	11-5	13-2	4-6	6-7	8-4	10-2	11-10
	Hem-Fir	SS	7-6	11-10	15-7	19-1	22-1	7-6	11-0	13-11	17-0	19-9
	Hem-Fir	#1	6-11	10-2	12-10	15-8	18-2	6-2	9-1	11-6	14-0	16-3
	Hem-Fir	#2	6-7	9-7	12-2	14-10	17-3	5-10	8-7	10-10	13-3	15-5
	Hem-Fir	#3	5-0	7-4	9-4	11-5	13-2	4-6	6-7	8-4	10-2	11-10
	Southern Pine	SS	7-10	12-3	16-2	20-8	25-1	7-10	12-3	16-2	19-8	23-0
	Southern Pine	#1	7-8	11-9	14-9	17-6	20-11	7-1	10-6	13-2	15-8	18-8
	Southern Pine	#2	7-1	10-2	13-2	15-9	18-5	6-4	9-2	11-9	14-1	16-6
	Southern Pine	#3	5-4	7-11	10-1	11-11	14-2	4-9	7-1	9-0	10-8	12-8
	Spruce-Pine-Fir	SS	7-4	11-7	14-9	18-0	20-11	7-1	10-5	13-2	16-1	18-8
	Spruce-Pine-Fir	#1	6-8	9-9	12-4	15-1	17-6	5-11	8-8	11-0	13-6	15-7
	Spruce-Pine-Fir	#2	6-8	9-9	12-4	15-1	17-6	5-11	8-8	11-0	13-6	15-7
	Spruce-Pine-Fir	#3	5-0	7-4	9-4	11-5	13-2	4-6	6-7	8-4	10-2	11-10

For SI: 1 inch = 25.4 mm, 1 foot = 304.8 mm, 1 pound per square foot = 47.9 N/m<sup>2</sup>.

**TABLE 2308.7.2(4)**  
**RAFTER SPANS FOR COMMON LUMBER SPECIES**  
 (Ground Snow Load = 50 pounds per square foot, Ceiling Not Attached to Rafters,  $L/\Delta = 180$ )

RAFTER SPACING (inches)	SPECIES AND GRADE		DEAD LOAD = 10 pounds per square foot					DEAD LOAD = 20 pounds per square foot				
			2 x 4	2 x 6	2 x 8	2 x 10	2 x 12	2 x 4	2 x 6	2 x 8	2 x 10	2 x 12
			Maximum rafter spans									
			(ft. - in.)	(ft. - in.)	(ft. - in.)	(ft. - in.)	(ft. - in.)	(ft. - in.)	(ft. - in.)	(ft. - in.)	(ft. - in.)	(ft. - in.)
12	Douglas Fir-Larch	SS	8-5	13-3	17-6	22-4	26-0	8-5	13-3	17-0	20-9	24-10
	Douglas Fir-Larch	#1	8-2	12-0	15-3	18-7	21-7	7-7	11-2	14-1	17-3	20-0
	Douglas Fir-Larch	#2	7-8	11-3	14-3	17-5	20-2	7-1	10-5	13-2	16-1	18-8
	Douglas Fir-Larch	#3	5-10	8-6	10-9	13-2	15-3	5-5	7-10	10-0	12-2	14-1
	Hem-Fir	SS	8-0	12-6	16-6	21-1	25-6	8-0	12-6	16-6	20-4	23-7
	Hem-Fir	#1	7-10	11-9	14-10	18-1	21-0	7-5	10-10	13-9	16-9	19-5
	Hem-Fir	#2	7-5	11-1	14-0	17-2	19-11	7-0	10-3	13-0	15-10	18-5
	Hem-Fir	#3	5-10	8-6	10-9	13-2	15-3	5-5	7-10	10-0	12-2	14-1
	Southern Pine	SS	8-4	13-0	17-2	21-11	26-0	8-4	13-0	17-2	21-11	26-0
	Southern Pine	#1	8-2	12-10	16-10	20-3	24-1	8-2	12-6	15-9	18-9	22-4
	Southern Pine	#2	8-0	11-9	15-3	18-2	21-3	7-7	10-11	14-1	16-10	19-9
	Southern Pine	#3	6-2	9-2	11-8	13-9	16-4	5-9	8-5	10-9	12-9	15-2
	Spruce-Pine-Fir	SS	7-10	12-3	16-2	20-8	24-1	7-10	12-3	15-9	19-3	22-4
	Spruce-Pine-Fir	#1	7-8	11-3	14-3	17-5	20-2	7-1	10-5	13-2	16-1	18-8
	Spruce-Pine-Fir	#2	7-8	11-3	14-3	17-5	20-2	7-1	10-5	13-2	16-1	18-8
	Spruce-Pine-Fir	#3	5-10	8-6	10-9	13-2	15-3	5-5	7-10	10-0	12-2	14-1
16	Douglas Fir-Larch	SS	7-8	12-1	15-10	19-5	22-6	7-8	11-7	14-8	17-11	20-10
	Douglas Fir-Larch	#1	7-1	10-5	13-2	16-1	18-8	6-7	9-8	12-2	14-11	17-3
	Douglas Fir-Larch	#2	6-8	9-9	12-4	15-1	17-6	6-2	9-0	11-5	13-11	16-2
	Douglas Fir-Larch	#3	5-0	7-4	9-4	11-5	13-2	4-8	6-10	8-8	10-6	12-3
	Hem-Fir	SS	7-3	11-5	15-0	19-1	22-1	7-3	11-5	14-5	17-8	20-5
	Hem-Fir	#1	6-11	10-2	12-10	15-8	18-2	6-5	9-5	11-11	14-6	16-10
	Hem-Fir	#2	6-7	9-7	12-2	14-10	17-3	6-1	8-11	11-3	13-9	15-11
	Hem-Fir	#3	5-0	7-4	9-4	11-5	13-2	4-8	6-10	8-8	10-6	12-3
	Southern Pine	SS	7-6	11-10	15-7	19-11	24-3	7-6	11-10	15-7	19-11	23-10
	Southern Pine	#1	7-5	11-7	14-9	17-6	20-11	7-4	10-10	13-8	16-2	19-4
	Southern Pine	#2	7-1	10-2	13-2	15-9	18-5	6-7	9-5	12-2	14-7	17-1
	Southern Pine	#3	5-4	7-11	10-1	11-11	14-2	4-11	7-4	9-4	11-0	13-1
	Spruce-Pine-Fir	SS	7-1	11-2	14-8	18-0	20-11	7-1	10-9	13-8	16-8	19-4
	Spruce-Pine-Fir	#1	6-8	9-9	12-4	15-1	17-6	6-2	9-0	11-5	13-11	16-2
	Spruce-Pine-Fir	#2	6-8	9-9	12-4	15-1	17-6	6-2	9-0	11-5	13-11	16-2
	Spruce-Pine-Fir	#3	5-0	7-4	9-4	11-5	13-2	4-8	6-10	8-8	10-6	12-3

*(continued)*

**TABLE 2308.7.2(4)—continued**  
**RAFTER SPANS FOR COMMON LUMBER SPECIES**  
 (Ground Snow Load = 50 pounds per square foot, Ceiling Not Attached to Rafters,  $L/\Delta = 180$ )

RAFTER SPACING (inches)	SPECIES AND GRADE		DEAD LOAD = 10 pounds per square foot					DEAD LOAD = 20 pounds per square foot				
			2 x 4	2 x 6	2 x 8	2 x 10	2 x 12	2 x 4	2 x 6	2 x 8	2 x 10	2 x 12
			Maximum rafter spans									
			(ft. - in.)	(ft. - in.)	(ft. - in.)	(ft. - in.)	(ft. - in.)	(ft. - in.)	(ft. - in.)	(ft. - in.)	(ft. - in.)	(ft. - in.)
19.2	Douglas Fir-Larch	SS	7-3	11-4	14-6	17-8	20-6	7-3	10-7	13-5	16-5	19-0
	Douglas Fir-Larch	#1	6-6	9-6	12-0	14-8	17-1	6-0	8-10	11-2	13-7	15-9
	Douglas Fir-Larch	#2	6-1	8-11	11-3	13-9	15-11	5-7	8-3	10-5	12-9	14-9
	Douglas Fir-Larch	#3	4-7	6-9	8-6	10-5	12-1	4-3	6-3	7-11	9-7	11-2
	Hem-Fir	SS	6-10	10-9	14-2	17-5	20-2	6-10	10-5	13-2	16-1	18-8
	Hem-Fir	#1	6-4	9-3	11-9	14-4	16-7	5-10	8-7	10-10	13-3	15-5
	Hem-Fir	#2	6-0	8-9	11-1	13-7	15-9	5-7	8-1	10-3	12-7	14-7
	Hem-Fir	#3	4-7	6-9	8-6	10-5	12-1	4-3	6-3	7-11	9-7	11-2
	Southern Pine	SS	7-1	11-2	14-8	18-9	22-10	7-1	11-2	14-8	18-7	21-9
	Southern Pine	#1	7-0	10-8	13-5	16-0	19-1	6-8	9-11	12-5	14-10	17-8
	Southern Pine	#2	6-6	9-4	12-0	14-4	16-10	6-0	8-8	11-2	13-4	15-7
	Southern Pine	#3	4-11	7-3	9-2	10-10	12-11	4-6	6-8	8-6	10-1	12-0
	Spruce-Pine-Fir	SS	6-8	10-6	13-5	16-5	19-1	6-8	9-10	12-5	15-3	17-8
	Spruce-Pine-Fir	#1	6-1	8-11	11-3	13-9	15-11	5-7	8-3	10-5	12-9	14-9
	Spruce-Pine-Fir	#2	6-1	8-11	11-3	13-9	15-11	5-7	8-3	10-5	12-9	14-9
	Spruce-Pine-Fir	#3	4-7	6-9	8-6	10-5	12-1	4-3	6-3	7-11	9-7	11-2
24	Douglas Fir-Larch	SS	6-8	10-3	13-0	15-10	18-4	6-6	9-6	12-0	14-8	17-0
	Douglas Fir-Larch	#1	5-10	8-6	10-9	13-2	15-3	5-5	7-10	10-0	12-2	14-1
	Douglas Fir-Larch	#2	5-5	7-11	10-1	12-4	14-3	5-0	7-4	9-4	11-5	13-2
	Douglas Fir-Larch	#3	4-1	6-0	7-7	9-4	10-9	3-10	5-7	7-1	8-7	10-0
	Hem-Fir	SS	6-4	9-11	12-9	15-7	18-0	6-4	9-4	11-9	14-5	16-8
	Hem-Fir	#1	5-8	8-3	10-6	12-10	14-10	5-3	7-8	9-9	11-10	13-9
	Hem-Fir	#2	5-4	7-10	9-11	12-1	14-1	4-11	7-3	9-2	11-3	13-0
	Hem-Fir	#3	4-1	6-0	7-7	9-4	10-9	3-10	5-7	7-1	8-7	10-0
	Southern Pine	SS	6-7	10-4	13-8	17-5	21-0	6-7	10-4	13-8	16-7	19-5
	Southern Pine	#1	6-5	9-7	12-0	14-4	17-1	6-0	8-10	11-2	13-3	15-9
	Southern Pine	#2	5-10	8-4	10-9	12-10	15-1	5-5	7-9	10-0	11-11	13-11
	Southern Pine	#3	4-4	6-5	8-3	9-9	11-7	4-1	6-0	7-7	9-0	10-8
	Spruce-Pine-Fir	SS	6-2	9-6	12-0	14-8	17-1	6-0	8-10	11-2	13-7	15-9
	Spruce-Pine-Fir	#1	5-5	7-11	10-1	12-4	14-3	5-0	7-4	9-4	11-5	13-2
	Spruce-Pine-Fir	#2	5-5	7-11	10-1	12-4	14-3	5-0	7-4	9-4	11-5	13-2
	Spruce-Pine-Fir	#3	4-1	6-0	7-7	9-4	10-9	3-10	5-7	7-1	8-7	10-0

For SI: 1 inch = 25.4 mm, 1 foot = 304.8 mm, 1 pound per square foot = 47.9 N/m<sup>2</sup>.



**TABLE 2308.7.2(5)**  
**RAFTER SPANS FOR COMMON LUMBER SPECIES**  
 (Ground Snow Load = 30 pounds per square foot, Ceiling Attached to Rafters,  $L/\Delta = 240$ )

RAFTER SPACING (inches)	SPECIES AND GRADE	DEAD LOAD = 10 pounds per square foot					DEAD LOAD = 20 pounds per square foot				
		2 x 4	2 x 6	2 x 8	2 x 10	2 x 12	2 x 4	2 x 6	2 x 8	2 x 10	2 x 12
		Maximum rafter spans									
		(ft. - in.)	(ft. - in.)	(ft. - in.)	(ft. - in.)	(ft. - in.)	(ft. - in.)	(ft. - in.)	(ft. - in.)	(ft. - in.)	(ft. - in.)
12	Douglas Fir-Larch SS	9-1	14-4	18-10	24-1	26-0	9-1	14-4	18-10	24-1	26-0
	Douglas Fir-Larch #1	8-9	13-9	18-2	22-9	26-0	8-9	13-2	16-8	20-4	23-7
	Douglas Fir-Larch #2	8-7	13-6	17-5	21-4	24-8	8-5	12-4	15-7	19-1	22-1
	Douglas Fir-Larch #3	7-1	10-5	13-2	16-1	18-8	6-4	9-4	11-9	14-5	16-8
	Hem-Fir SS	8-7	13-6	17-10	22-9	26-0	8-7	13-6	17-10	22-9	26-0
	Hem-Fir #1	8-5	13-3	17-5	22-2	25-9	8-5	12-10	16-3	19-10	23-0
	Hem-Fir #2	8-0	12-7	16-7	21-0	24-4	8-0	12-2	15-4	18-9	21-9
	Hem-Fir #3	7-1	10-5	13-2	16-1	18-8	6-4	9-4	11-9	14-5	16-8
	Southern Pine SS	8-11	14-1	18-6	23-8	26-0	8-11	14-1	18-6	23-8	26-0
	Southern Pine #1	8-9	13-9	18-2	23-2	26-0	8-9	13-9	18-2	22-2	26-0
	Southern Pine #2	8-7	13-6	17-10	22-3	26-0	8-7	12-11	16-8	19-11	23-4
	Southern Pine #3	7-7	11-2	14-3	16-10	20-0	6-9	10-0	12-9	15-1	17-11
	Spruce-Pine-Fir SS	8-5	13-3	17-5	22-3	26-0	8-5	13-3	17-5	22-3	26-0
	Spruce-Pine-Fir #1	8-3	12-11	17-0	21-4	24-8	8-3	12-4	15-7	19-1	22-1
	Spruce-Pine-Fir #2	8-3	12-11	17-0	21-4	24-8	8-3	12-4	15-7	19-1	22-1
	Spruce-Pine-Fir #3	7-1	10-5	13-2	16-1	18-8	6-4	9-4	11-9	14-5	16-8
16	Douglas Fir-Larch SS	8-3	13-0	17-2	21-10	26-0	8-3	13-0	17-2	21-3	24-8
	Douglas Fir-Larch #1	8-0	12-6	16-2	19-9	22-10	7-10	11-5	14-5	17-8	20-5
	Douglas Fir-Larch #2	7-10	11-11	15-1	18-5	21-5	7-3	10-8	13-6	16-6	19-2
	Douglas Fir-Larch #3	6-2	9-0	11-5	13-11	16-2	5-6	8-1	10-3	12-6	14-6
	Hem-Fir SS	7-10	12-3	16-2	20-8	25-1	7-10	12-3	16-2	20-8	24-2
	Hem-Fir #1	7-8	12-0	15-9	19-3	22-3	7-7	11-1	14-1	17-2	19-11
	Hem-Fir #2	7-3	11-5	14-11	18-2	21-1	7-2	10-6	13-4	16-3	18-10
	Hem-Fir #3	6-2	9-0	11-5	13-11	16-2	5-6	8-1	10-3	12-6	14-6
	Southern Pine SS	8-1	12-9	16-10	21-6	26-0	8-1	12-9	16-10	21-6	26-0
	Southern Pine #1	8-0	12-6	16-6	21-1	25-7	8-0	12-6	16-2	19-2	22-10
	Southern Pine #2	7-10	12-3	16-2	19-3	22-7	7-10	11-2	14-5	17-3	20-2
	Southern Pine #3	6-7	9-8	12-4	14-7	17-4	5-10	8-8	11-0	13-0	15-6
	Spruce-Pine-Fir SS	7-8	12-0	15-10	20-2	24-7	7-8	12-0	15-10	19-9	22-10
	Spruce-Pine-Fir #1	7-6	11-9	15-1	18-5	21-5	7-3	10-8	13-6	16-6	19-2
	Spruce-Pine-Fir #2	7-6	11-9	15-1	18-5	21-5	7-3	10-8	13-6	16-6	19-2
	Spruce-Pine-Fir #3	6-2	9-0	11-5	13-11	16-2	5-6	8-1	10-3	12-6	14-6

(continued)



**TABLE 2308.7.2(5)—continued**  
**RAFTER SPANS FOR COMMON LUMBER SPECIES**  
 (Ground Snow Load = 30 pounds per square foot, Ceiling Attached to Rafters,  $L/\Delta = 240$ )

11

RAFTER SPACING (inches)	SPECIES AND GRADE		DEAD LOAD = 10 pounds per square foot					DEAD LOAD = 20 pounds per square foot				
			2 x 4	2 x 6	2 x 8	2 x 10	2 x 12	2 x 4	2 x 6	2 x 8	2 x 10	2 x 12
			Maximum rafter spans									
			(ft. - in.)	(ft. - in.)	(ft. - in.)	(ft. - in.)	(ft. - in.)	(ft. - in.)	(ft. - in.)	(ft. - in.)	(ft. - in.)	(ft. - in.)
19.2	Douglas Fir-Larch	SS	7-9	12-3	16-1	20-7	25-0	7-9	12-3	15-10	19-5	22-6
	Douglas Fir-Larch	#1	7-6	11-8	14-9	18-0	20-11	7-1	10-5	13-2	16-1	18-8
	Douglas Fir-Larch	#2	7-4	10-11	13-9	16-10	19-6	6-8	9-9	12-4	15-1	17-6
	Douglas Fir-Larch	#3	5-7	8-3	10-5	12-9	14-9	5-0	7-4	9-4	11-5	13-2
	Hem-Fir	SS	7-4	11-7	15-3	19-5	23-7	7-4	11-7	15-3	19-1	22-1
	Hem-Fir	#1	7-2	11-4	14-4	17-7	20-4	6-11	10-2	12-10	15-8	18-2
	Hem-Fir	#2	6-10	10-9	13-7	16-7	19-3	6-7	9-7	12-2	14-10	17-3
	Hem-Fir	#3	5-7	8-3	10-5	12-9	14-9	5-0	7-4	9-4	11-5	13-2
	Southern Pine	SS	7-8	12-0	15-10	20-2	24-7	7-8	12-0	15-10	20-2	24-7
	Southern Pine	#1	7-6	11-9	15-6	19-7	23-4	7-6	11-9	14-9	17-6	20-11
	Southern Pine	#2	7-4	11-5	14-9	17-7	20-7	7-1	10-2	13-2	15-9	18-5
	Southern Pine	#3	6-0	8-10	11-3	13-4	15-10	5-4	7-11	10-1	11-11	14-2
	Spruce-Pine-Fir	SS	7-2	11-4	14-11	19-0	23-1	7-2	11-4	14-9	18-0	20-11
	Spruce-Pine-Fir	#1	7-0	10-11	13-9	16-10	19-6	6-8	9-9	12-4	15-1	17-6
	Spruce-Pine-Fir	#2	7-0	10-11	13-9	16-10	19-6	6-8	9-9	12-4	15-1	17-6
	Spruce-Pine-Fir	#3	5-7	8-3	10-5	12-9	14-9	5-0	7-4	9-4	11-5	13-2
24	Douglas Fir-Larch	SS	7-3	11-4	15-0	19-1	22-6	7-3	11-3	14-2	17-4	20-1
	Douglas Fir-Larch	#1	7-0	10-5	13-2	16-1	18-8	6-4	9-4	11-9	14-5	16-8
	Douglas Fir-Larch	#2	6-8	9-9	12-4	15-1	17-6	5-11	8-8	11-0	13-6	15-7
	Douglas Fir-Larch	#3	5-0	7-4	9-4	11-5	13-2	4-6	6-7	8-4	10-2	11-10
	Hem-Fir	SS	6-10	10-9	14-2	18-0	21-11	6-10	10-9	13-11	17-0	19-9
	Hem-Fir	#1	6-8	10-2	12-10	15-8	18-2	6-2	9-1	11-6	14-0	16-3
	Hem-Fir	#2	6-4	9-7	12-2	14-10	17-3	5-10	8-7	10-10	13-3	15-5
	Hem-Fir	#3	5-0	7-4	9-4	11-5	13-2	4-6	6-7	8-4	10-2	11-10
	Southern Pine	SS	7-1	11-2	14-8	18-9	22-10	7-1	11-2	14-8	18-9	22-10
	Southern Pine	#1	7-0	10-11	14-5	17-6	20-11	7-0	10-6	13-2	15-8	18-8
	Southern Pine	#2	6-10	10-2	13-2	15-9	18-5	6-4	9-2	11-9	14-1	16-6
	Southern Pine	#3	5-4	7-11	10-1	11-11	14-2	4-9	7-1	9-0	10-8	12-8
	Spruce-Pine-Fir	SS	6-8	10-6	13-10	17-8	20-11	6-8	10-5	13-2	16-1	18-8
	Spruce-Pine-Fir	#1	6-6	9-9	12-4	15-1	17-6	5-11	8-8	11-0	13-6	15-7
	Spruce-Pine-Fir	#2	6-6	9-9	12-4	15-1	17-6	5-11	8-8	11-0	13-6	15-7
	Spruce-Pine-Fir	#3	5-0	7-4	9-4	11-5	13-2	4-6	6-7	8-4	10-2	11-10

For SI: 1 inch = 25.4 mm, 1 foot = 304.8 mm, 1 pound per square foot = 47.9 N/m<sup>2</sup>.



**TABLE 2308.7.2(6)**  
**RAFTER SPANS FOR COMMON LUMBER SPECIES**  
 (Ground Snow Load = 50 pounds per square foot, Ceiling Attached to Rafters,  $L/\Delta = 240$ )

RAFTER SPACING (inches)	SPECIES AND GRADE		DEAD LOAD = 10 pounds per square foot					DEAD LOAD = 20 pounds per square foot				
			2 x 4	2 x 6	2 x 8	2 x 10	2 x 12	2 x 4	2 x 6	2 x 8	2 x 10	2 x 12
			Maximum rafter spans									
			(ft. - in.)	(ft. - in.)	(ft. - in.)	(ft. - in.)	(ft. - in.)	(ft. - in.)	(ft. - in.)	(ft. - in.)	(ft. - in.)	(ft. - in.)
12	Douglas Fir-Larch	SS	7-8	12-1	15-11	20-3	24-8	7-8	12-1	15-11	20-3	24-0
	Douglas Fir-Larch	#1	7-5	11-7	15-3	18-7	21-7	7-5	11-2	14-1	17-3	20-0
	Douglas Fir-Larch	#2	7-3	11-3	14-3	17-5	20-2	7-1	10-5	13-2	16-1	18-8
	Douglas Fir-Larch	#3	5-10	8-6	10-9	13-2	15-3	5-5	7-10	10-0	12-2	14-1
	Hem-Fir	SS	7-3	11-5	15-0	19-2	23-4	7-3	11-5	15-0	19-2	23-4
	Hem-Fir	#1	7-1	11-2	14-8	18-1	21-0	7-1	10-10	13-9	16-9	19-5
	Hem-Fir	#2	6-9	10-8	14-0	17-2	19-11	6-9	10-3	13-0	15-10	18-5
	Hem-Fir	#3	5-10	8-6	10-9	13-2	15-3	5-5	7-10	10-0	12-2	14-1
	Southern Pine	SS	7-6	11-0	15-7	19-11	24-3	7-6	11-10	15-7	19-11	24-3
	Southern Pine	#1	7-5	11-7	15-4	19-7	23-9	7-5	11-7	15-4	18-9	22-4
	Southern Pine	#2	7-3	11-5	15-0	18-2	21-3	7-3	10-11	14-1	16-10	19-9
	Southern Pine	#3	6-2	9-2	11-8	13-9	16-4	5-9	8-5	10-9	12-9	15-2
	Spruce-Pine-Fir	SS	7-1	11-2	14-8	18-9	22-10	7-1	11-2	14-8	18-9	22-4
	Spruce-Pine-Fir	#1	6-11	10-11	14-3	17-5	20-2	6-11	10-5	13-2	16-1	18-8
	Spruce-Pine-Fir	#2	6-11	10-11	14-3	17-5	20-2	6-11	10-5	13-2	16-1	18-8
	Spruce-Pine-Fir	#3	5-10	8-6	10-9	13-2	15-3	5-5	7-10	10-0	12-2	14-1
16	Douglas Fir-Larch	SS	7-0	11-0	14-5	18-5	22-5	7-0	11-0	14-5	17-11	20-10
	Douglas Fir-Larch	#1	6-9	10-5	13-2	16-1	18-8	6-7	9-8	12-2	14-11	17-3
	Douglas Fir-Larch	#2	6-7	9-9	12-4	15-1	17-6	6-2	9-0	11-5	13-11	16-2
	Douglas Fir-Larch	#3	5-0	7-4	9-4	11-5	13-2	4-8	6-10	8-8	10-6	12-3
	Hem-Fir	SS	6-7	10-4	13-8	17-5	21-2	6-7	10-4	13-8	17-5	20-5
	Hem-Fir	#1	6-5	10-2	12-10	15-8	18-2	6-5	9-5	11-11	14-6	16-10
	Hem-Fir	#2	6-2	9-7	12-2	14-10	17-3	6-1	8-11	11-3	13-9	15-11
	Hem-Fir	#3	5-0	7-4	9-4	11-5	13-2	4-8	6-10	8-8	10-6	12-3
	Southern Pine	SS	6-10	10-9	14-2	18-1	22-0	6-10	10-9	14-2	18-1	22-0
	Southern Pine	#1	6-9	10-7	13-11	17-6	20-11	6-9	10-7	13-8	16-2	19-4
	Southern Pine	#2	6-7	10-2	13-2	15-9	18-5	6-7	9-5	12-2	14-7	17-1
	Southern Pine	#3	5-4	7-11	10-1	11-11	14-2	4-11	7-4	9-4	11-0	13-1
	Spruce-Pine-Fir	SS	6-5	10-2	13-4	17-0	20-9	6-5	10-2	13-4	16-8	19-4
	Spruce-Pine-Fir	#1	6-4	9-9	12-4	15-1	17-6	6-2	9-0	11-5	13-11	16-2
	Spruce-Pine-Fir	#2	6-4	9-9	12-4	15-1	17-6	6-2	9-0	11-5	13-11	16-2
	Spruce-Pine-Fir	#3	5-0	7-4	9-4	11-5	13-2	4-8	6-10	8-8	10-6	12-3

(continued)

**TABLE 2308.7.2(6)—continued**  
**RAFTER SPANS FOR COMMON LUMBER SPECIES**  
**(Ground Snow Load = 50 pounds per square foot, Ceiling Attached to Rafters,  $L/\Delta = 240$ )**

11

RAFTER SPACING (inches)	SPECIES AND GRADE		DEAD LOAD = 10 pounds per square foot					DEAD LOAD = 20 pounds per square foot				
			2 × 4	2 × 6	2 × 8	2 × 10	2 × 12	2 × 4	2 × 6	2 × 8	2 × 10	2 × 12
			Maximum rafter spans									
			(ft. - in.)	(ft. - in.)	(ft. - in.)	(ft. - in.)	(ft. - in.)	(ft. - in.)	(ft. - in.)	(ft. - in.)	(ft. - in.)	(ft. - in.)
19.2	Douglas Fir-Larch	SS	6-7	10-4	13-7	17-4	20-6	6-7	10-4	13-5	16-5	19-0
	Douglas Fir-Larch	#1	6-4	9-6	12-0	14-8	17-1	6-0	8-10	11-2	13-7	15-9
	Douglas Fir-Larch	#2	6-1	8-11	11-3	13-9	15-11	5-7	8-3	10-5	12-9	14-9
	Douglas Fir-Larch	#3	4-7	6-9	8-6	10-5	12-1	4-3	6-3	7-11	9-7	11-2
	Hem-Fir	SS	6-2	9-9	12-10	16-5	19-11	6-2	9-9	12-10	16-1	18-8
	Hem-Fir	#1	6-1	9-3	11-9	14-4	16-7	5-10	8-7	10-10	13-3	15-5
	Hem-Fir	#2	5-9	8-9	11-1	13-7	15-9	5-7	8-1	10-3	12-7	14-7
	Hem-Fir	#3	4-7	6-9	8-6	10-5	12-1	4-3	6-3	7-11	9-7	11-2
	Southern Pine	SS	6-5	10-2	13-4	17-0	20-9	6-5	10-2	13-4	17-0	20-9
	Southern Pine	#1	6-4	9-11	13-1	16-0	19-1	6-4	9-11	12-5	14-10	17-8
	Southern Pine	#2	6-2	9-4	12-0	14-4	16-10	6-0	8-8	11-2	13-4	15-7
	Southern Pine	#3	4-11	7-3	9-2	10-10	12-11	4-6	6-8	8-6	10-1	12-0
	Spruce-Pine-Fir	SS	6-1	9-6	12-7	16-0	19-1	6-1	9-6	12-5	15-3	17-8
	Spruce-Pine-Fir	#1	5-11	8-11	11-3	13-9	15-11	5-7	8-3	10-5	12-9	14-9
	Spruce-Pine-Fir	#2	5-11	8-11	11-3	13-9	15-11	5-7	8-3	10-5	12-9	14-9
	Spruce-Pine-Fir	#3	4-7	6-9	8-6	10-5	12-1	4-3	6-3	7-11	9-7	11-2
24	Douglas Fir-Larch	SS	6-1	9-7	12-7	15-10	18-4	6-1	9-6	12-0	14-8	17-0
	Douglas Fir-Larch	#1	5-10	8-6	10-9	13-2	15-3	5-5	7-10	10-0	12-2	14-1
	Douglas Fir-Larch	#2	5-5	7-11	10-1	12-4	14-3	5-0	7-4	9-4	11-5	13-2
	Douglas Fir-Larch	#3	4-1	6-0	7-7	9-4	10-9	3-10	5-7	7-1	8-7	10-0
	Hem-Fir	SS	5-9	9-1	11-11	15-12	18-0	5-9	9-1	11-9	14-5	16-8
	Hem-Fir	#1	5-8	8-3	10-6	12-10	14-10	5-3	7-8	9-9	11-10	13-9
	Hem-Fir	#2	5-4	7-10	9-11	12-1	14-1	4-11	7-3	9-2	11-3	13-0
	Hem-Fir	#3	4-1	6-0	7-7	9-4	10-9	3-10	5-7	7-1	8-7	10-0
	Southern Pine	SS	6-0	9-5	12-5	15-10	19-3	6-0	9-5	12-5	15-10	19-3
	Southern Pine	#1	5-10	9-3	12-0	14-4	17-1	5-10	8-10	11-2	13-3	15-9
	Southern Pine	#2	5-9	8-4	10-9	12-10	15-1	5-5	7-9	10-0	11-11	13-11
	Southern Pine	#3	4-4	6-5	8-3	9-9	11-7	4-1	6-0	7-7	9-0	10-8
	Spruce-Pine-Fir	SS	5-8	8-10	11-8	14-8	17-1	5-8	8-10	11-2	13-7	15-9
	Spruce-Pine-Fir	#1	5-5	7-11	10-1	12-4	14-3	5-0	7-4	9-4	11-5	13-2
	Spruce-Pine-Fir	#2	5-5	7-11	10-1	12-4	14-3	5-0	7-4	9-4	11-5	13-2
	Spruce-Pine-Fir	#3	4-1	6-0	7-7	9-4	10-9	3-10	5-7	7-1	8-7	10-0

For SI: 1 inch = 25.4 mm, 1 foot = 304.8 mm, 1 pound per square foot = 47.9 N/m<sup>2</sup>.

**TABLE 2308.7.3.1  
RAFTER TIE CONNECTIONS<sup>g</sup>**

RAFTER SLOPE	TIE SPACING (inches)	NO SNOW LOAD				GROUND SNOW LOAD (pound per square foot)							
						30 pounds per square foot				50 pounds per square foot			
		Roof span (feet)											
		12	20	28	36	12	20	28	36	12	20	28	36
Required number of 16d common (3 1/2" x 0.162") nails <sup>a, b</sup> per connection <sup>c, d, e, f</sup>													
3:12	12	4	6	8	10	4	6	8	11	5	8	12	15
	16	5	7	10	13	5	8	11	14	6	11	15	20
	24	7	11	15	19	7	11	16	21	9	16	23	30
	32	10	14	19	25	10	16	22	28	12	27	30	40
	48	14	21	29	37	14	32	36	42	18	32	46	60
4:12	12	3	4	5	6	3	5	6	8	4	6	9	11
	16	3	5	7	8	4	6	8	11	5	8	12	15
	24	4	7	10	12	5	9	12	16	7	12	17	22
	32	6	9	13	16	8	12	16	22	10	16	24	30
	48	8	14	19	24	10	18	24	32	14	24	34	44
5:12	12	3	3	4	5	3	4	5	7	3	5	7	9
	16	3	4	5	7	3	5	7	9	4	7	9	12
	24	4	6	8	10	4	7	10	13	6	10	14	18
	32	5	8	10	13	6	10	14	18	8	14	18	24
	48	7	11	15	20	8	14	20	26	12	20	28	36
7:12	12	3	3	3	4	3	3	4	5	3	4	5	7
	16	3	3	4	5	3	4	5	6	3	5	7	9
	24	3	4	6	7	3	5	7	9	4	7	10	13
	32	4	6	8	10	4	8	10	12	6	10	14	18
	48	5	8	11	14	6	10	14	18	9	14	20	26
9:12	12	3	3	3	3	3	3	3	4	3	3	4	5
	16	3	3	3	4	3	3	4	5	3	4	5	7
	24	3	3	5	6	3	4	6	7	3	6	8	10
	32	3	4	6	8	4	6	8	10	5	8	10	14
	48	4	6	9	11	5	8	12	14	7	12	16	20
12:12	12	3	3	3	3	3	3	3	3	3	3	3	4
	16	3	3	3	3	3	3	3	4	3	3	4	5
	24	3	3	3	4	3	3	4	6	3	4	6	8
	32	3	3	4	5	3	5	6	8	4	6	8	10
	48	3	4	6	7	4	7	8	12	6	8	12	16

For SI: 1 inch = 25.4 mm, 1 foot = 304.8 mm, 1 pound per square foot = 47.8 N/m<sup>2</sup>.

a. 40d box (5" x 0.162") or 16d sinker (3 1/4" x 0.148") nails are permitted to be substituted for 16d common (3 1/2" x 0.162") nails.

b. Nailing requirements are permitted to be reduced 25 percent if nails are clinched.

c. Rafter tie heel joint connections are not required where the ridge is supported by a load-bearing wall, header or ridge beam.

d. When intermediate support of the rafter is provided by vertical struts or purlins to a load-bearing wall, the tabulated heel joint connection requirements are permitted to be reduced proportionally to the reduction in span.

e. Equivalent nailing patterns are required for ceiling joist to ceiling joist lap splices.

f. Connected members shall be of sufficient size to prevent splitting due to nailing.

g. For snow loads less than 30 pounds per square foot, the required number of nails is permitted to be reduced by multiplying by the ratio of actual snow load plus 10 divided by 40, but not less than the number required for no snow load.

**TABLE 2308.7.5  
REQUIRED RATING OF APPROVED UPLIFT CONNECTORS (pounds)<sup>a, b, c, e, f, g, h</sup>**

NOMINAL DESIGN WIND SPEED, $V_{asd}$ <sup>i</sup>	ROOF SPAN (feet)							OVERHANGS (pounds/feet) <sup>d</sup>
	12	20	24	28	32	36	40	
85	-72	-120	-145	-169	-193	-217	-241	-38.55
90	-91	-151	-181	-212	-242	-272	-302	-43.22
100	-131	-281	-262	-305	-349	-393	-436	-53.36
110	-175	-292	-351	-409	-467	-526	-584	-64.56

For SI: 1 inch = 25.4 mm, 1 foot = 304.8 mm, 1 mile per hour = 1.61 km/hr, 1 pound = 0.454 Kg, 1 pound/foot = 14.5939 N/m.

- a. The uplift connection requirements are based on a 30-foot mean roof height located in Exposure B. For Exposure C or D and for other mean roof heights, multiply the above loads by the adjustment coefficients below.

EXPOSURE	Mean Roof Height (feet)									
	15	20	25	30	35	40	45	50	55	60
B	1.00	1.00	1.00	1.00	1.05	1.09	1.12	1.16	1.19	1.22
C	1.21	1.29	1.35	1.40	1.45	1.49	1.53	1.56	1.59	1.62
D	1.47	1.55	1.61	1.66	1.70	1.74	1.78	1.81	1.84	1.87

- b. The uplift connection requirements are based on the framing being spaced 24 inches on center. Multiply by 0.67 for framing spaced 16 inches on center and multiply by 0.5 for framing spaced 12 inches on center.
- c. The uplift connection requirements include an allowance for 10 pounds of dead load.
- d. The uplift connection requirements do not account for the effects of overhangs. The magnitude of the above loads shall be increased by adding the overhang loads found in the table. The overhang loads are also based on framing spaced 24 inches on center. The overhang loads given shall be multiplied by the overhang projection and added to the roof uplift value in the table.
- e. The uplift connection requirements are based upon wind loading on end zones as defined in Figure 28.6.3 of ASCE 7. Connection loads for connections located a distance of 20 percent of the least horizontal dimension of the building from the corner of the building are permitted to be reduced by multiplying the table connection value by 0.7 and multiplying the overhang load by 0.8.
- f. For wall-to-wall and wall-to-foundation connections, the capacity of the uplift connector is permitted to be reduced by 100 pounds for each full wall above. (For example, if a 500-pound rated connector is used on the roof framing, a 400-pound rated connector is permitted at the next floor level down.)
- g. Interpolation is permitted for intermediate values of  $V_{asd}$  and roof spans.
- h. The rated capacity of approved tie-down devices is permitted to include up to a 60-percent increase for wind effects where allowed by material specifications.
- i.  $V_{asd}$  shall be determined in accordance with Section 1609.3.1.

WOOD

**TABLE 2308.7.12  
ALLOWABLE SPANS FOR 2-INCH TONGUE-AND-GROOVE DECKING**

SPAN <sup>a</sup> (feet)	LIVE LOAD (pound per square foot)	DEFLECTION LIMIT	BENDING STRESS (f) (pound per square inch)	MODULUS OF ELASTICITY (E) (pound per square inch)
<b>Roofs</b>				
4	20	1/240 1/360	160	170,000 256,000
	30	1/240 1/360	210	256,000 384,000
	40	1/240 1/360	270	340,000 512,000
4.5	20	1/240 1/360	200	242,000 305,000
	30	1/240 1/360	270	363,000 405,000
	40	1/240 1/360	350	484,000 725,000
5.0	20	1/240 1/360	250	332,000 500,000
	30	1/240 1/360	330	495,000 742,000
	40	1/240 1/360	420	660,000 1,000,000
5.5	20	1/240 1/360	300	442,000 660,000
	30	1/240 1/360	400	662,000 998,000
	40	1/240 1/360	500	884,000 1,330,000
6.0	20	1/240 1/360	360	575,000 862,000
	30	1/240 1/360	480	862,000 1,295,000
	40	1/240 1/360	600	1,150,000 1,730,000

(continued)

**TABLE 2308.7.12—continued**  
**ALLOWABLE SPANS FOR 2-INCH TONGUE-AND-GROOVE DECKING**

SPAN <sup>a</sup> (feet)	LIVE LOAD (pound per square foot)	DEFLECTION LIMIT	BENDING STRESS (f) (pound per square inch)	MODULUS OF ELASTICITY (E) (pound per square inch)
<b>Roofs</b>				
6.5	20	1/240 1/360	420	595,000 892,000
	30	1/240 1/360	560	892,000 1,340,000
	40	1/240 1/360	700	1,190,000 1,730,000
7.0	20	1/240 1/360	490	910,000 1,360,000
	30	1/240 1/360	650	1,370,000 2,000,000
	40	1/240 1/360	810	1,820,000 2,725,000
7.5	20	1/240 1/360	560	1,125,000 1,685,000
	30	1/240 1/360	750	1,685,000 2,530,000
	40	1/240 1/360	930	2,250,000 3,380,000
8.0	20	1/240 1/360	640	1,360,000 2,040,000
	30	1/240 1/360	850	2,040,000 3,060,000
<b>Floors</b>				
4	40	1/360	840	1,000,000
4.5			950	1,300,000
5.0			1,060	1,600,000

For SI: 1 inch = 25.4 mm, 1 foot = 304.8 mm, 1 pound per square foot = 0.0479 kN/m<sup>2</sup>, 1 pound per square inch = 0.00689 N/mm<sup>2</sup>.

a. Spans are based on simple beam action with 10 pounds per square foot dead load and provisions for a 300-pound concentrated load on a 12-inch width of decking. Random layup is permitted in accordance with the provisions of Section 2308.10.9. Lumber thickness is 1½ inches nominal.

